



# Reliability and Resilience in the Balance

Building sustainable infrastructure for a reliable future.

A vision beyond Winter Storms Uri and Viola.



# REPORT PREPARED BY:

---

## American Society of Civil Engineers (ASCE) Texas Section

Beyond Storms Infrastructure Network  
Resilience (INR) Task Committee  
*(see page 123 for additional information)*

*Executive Summary released 21 January 2022  
Full Report released 16 February 2022*

2

# WHAT WE DO:

ASCE Texas Section is one of the largest and most active sections of the American Society of Civil Engineers, the oldest national civil engineering society in the United States. Established in 1913, the Texas Section represents nearly 10,000 members throughout Texas. The Section is headquartered in Austin and comprises 15 Branches around the state and Student Chapters at all the state's leading universities.

*Texas civil engineers are leaders in their communities, building a better quality of life across the street and around the world.*

# HOW TO CONTACT US:

ASCE Texas Section  
[www.TexASCE.org](http://www.TexASCE.org)  
(512) 472-8905  
[office@texasce.org](mailto:office@texasce.org)

1524 S Interstate 35, Ste 180  
Austin, Texas 78704

# Table of Contents

<b>Executive Summary</b> .....	<b>4</b>
<b>RECOMMENDED ACTIONS</b> .....	<b>7-19</b>
1. Invest in black start capacity to ensure reliable, fail-safe back-up .....	8
2. Restructure regulatory flaws negatively impacting dispatchable generation reliability...11	
3. Mitigate growing interdependency between infrastructure sectors .....	13
4. Implement Reliability focused incentives and regulations .....	16
5. Rebuild a reliability focused culture at ERCOT.....	19
<b>Detailed Network Report</b> .....	<b>20-54</b>
<b>Weather Overview – Winter Storms Uri and Viola</b> .....	<b>21</b>
Macro perspectives	
<b>Initial Storm Response Assessment and Report Focus</b> .....	<b>26</b>
<b>Overview of ERCOT</b> .....	<b>29</b>
<b>How does it work and what makes an electric system reliable?</b> .....	<b>29</b>
Transmission and distribution (T&D)	
Generation – including natural gas transportation & supply	
The market	
The end user	
<b>Risk, Reliability, &amp; Resilience</b> .....	<b>37</b>
Industry Tools: DOE and NERC	
ERCOT - Analysis tools and forecasted indicators	
• Model errors creating false sense of reliability	
• Independent assessment of ERCOT models & critical modeling issues	
• High level recommendations	
• Alignment of risk and responsibilities	
<b>Further Analysis</b> .....	<b>43</b>
Natural gas fuel supply failures	
Why was there chronic underinvestment?	
• ERCOT market design problems	
• Understanding the catastrophic risk of black start conditions	
• Negative impact of intermittent generation	
What does it cost to improve reliability vs. continued run to failure approach?	
The challenge of interdependence	
Policies that enhance or undermine reliability	
The challenge of institutional bias - The PUCT and ERCOT self-assessment	
Regulatory and political response: SB2 and SB3	
Where do we go from here?	
<b>Conclusion</b> .....	<b>52</b>
<b>End Notes</b> .....	<b>53</b>
<b>Sector Reports</b> .....	<b>55-121</b>
Telecommunications and Fiber.....	56
Drinking Water, Wastewater, and Stormwater.....	63
Electricity.....	86
Energy.....	99
Transportation .....	115
<b>Acknowledgments</b> .....	<b>122</b>

# Executive Summary

---

The twin impacts of Winter Storms Uri and Viola on Texas and its energy system was catastrophic. The consequences for Texans was tragic. These impacts included at least 210 Texans casualties during the storm and substantial and lingering economic impact to the entire region that is estimated to exceed \$200 - \$300 billion<sup>1</sup> in addition to disputes and securitizations. The economic impact of Uri and Viola was greater than the impact from either of the two most costly hurricanes<sup>2</sup> in US history, Harvey (\$145B) or Katrina (\$161B). In comparison, in 2019 Texans spent around \$37B on retail power during the year<sup>3</sup>. Regardless of the metric, from public safety to economic impact Uri and Viola deserve a comprehensive response to prevent recurrence.

Uri and Viola had direct impact on infrastructure across Texas, from agriculture to roads and homes that generated substantial economic and personal harm. It also complicated the response. Transportation corridors became impassable from accumulated precipitation, hindering the response capabilities of people and rescue & restoration operations, which led to further failures. There was no effective tool to allocate the direct impacts from the weather itself, what was directly impacted by the failure of the electric system and what were indirect impacts. However, ASCE Texas Section believes that the failure of the electricity grid was a material contributor to the economic harm and human tragedy experienced during and after Winter Storms Uri and Viola.

The Committee has also determined that the problems uncovered by the severe storm extend well beyond storm related issues. Texas has a substantial and growing electric system reliability and resilience problem. A reliable and resilient electric system in an increasingly electrified economy is critical to the safety and economic health of Texans. ASCE Texas Section's urgency concluded that the failures that caused overwhelming human and economic suffering during February *will* increase in frequency and duration due to legacy market design shortcomings, growing infrastructure interdependence, economic and population growth drivers, and aging equipment even if the frequency and severity of weather events remains unchanged.

Texas has long been a leader in energy and innovation. The Texas electric grid has been in a constant state of evolution to accommodate new technologies, grid expansions and satisfy growing demand since its formation. During the current transition, substantial federal and state incentives supporting new intermittent wind and solar resources have led to the dramatic growth of renewable energy resources in Texas. Recent and growing additions of utility scale energy storage confirm another stage of transition. ASCE Texas Section recognizes that the grid will continue to evolve and change as it adapts to the future needs of Texas. ASCE Texas Section does not subscribe to the view that reliability deterioration is an inevitable part of the "cost of transition" in the energy sector. Due to the extreme costs of reliability failure, it is reckless to believe that the energy market transition should somehow be used as justification or an excuse for reliability declines and extended load shedding events. For energy transition to work effectively and be accepted, it must occur without any sacrifice of reliability and resilience.

The energy industry is one of the most capital-intensive industries in the world. Like almost all critical infrastructure, it requires large, routine capital expenditures to support expansion, maintenance, and operations to meet demand. Policies, regulations, and market actions that distort, constrain, or negatively impact the flow of capital to needed investment starves reliability through deferred expansions, delayed maintenance, and reduced reliability investment. The reliability of critical infrastructure, from transportation and energy to water, wastewater, and telecoms, is heavily impacted either positively or negatively by the sufficiency and predictability of ongoing investments supporting maintenance and reliability upgrades.

There is a legacy of chronic under-investment to maintain critical infrastructure across the US. Many of the negative impacts of this under-investment are more acute for those individuals at the margin, relying on critical infrastructure with few viable options. Underfunding creates other problems including worsening public safety and compliance issues. This pattern of deferral and avoidance, results in a costly "run to failure" outcome followed by surprise that reliability and resilience was somehow compromised. This pattern of persistent underfunding must change. Some leading cities, like the City of Houston are implementing a "pay as you go" policy that includes reducing debt and keeping more current on maintenance and upgrades to their critical infrastructure. They understand that run to failure is not a strategy.

To understand the root cause of the problems created by Winter Storm Uri and Viola, it was necessary to look beyond

- 1) the physical infrastructure to include,
- 2) the impact of regulations that apply to the use of the infrastructure, and
- 3) the markets themselves.

The success or failure of the energy infrastructure system depends upon how well these three legs of the energy market work together. ASCE Texas Section identified two primary and related problems:

- 1) a failure to support reliable dispatchable power generation, and
- 2) the negative impact from sources of intermittent electric power generation.

This assessment concludes that

- 1) revenue insufficiency from ERCOT's energy-only market model, influenced by federal and state subsidization of intermittent resources, fails to adequately pay for reliable dispatchable generation and
- 2) that these market model deficiencies are the leading contributor to making the ERCOT system less reliable.

This market design and supporting rules and regulations in place rely on the “hope” that potential periodic scarcity premiums would be sufficient to incentivize long-term reliability investments. There is ample evidence that this hope is unfounded. According to Wood Mackenzie<sup>4</sup>, “...During the 10 years prior to 2021, ERCOT's Energy-only market did not provide a meaningful signal for natural gas or wind generators to winterize.” A dispatchable generator confronting this reality rationally is unlikely to invest in winterization, firm fuel supply, dual fuel flexibility or make other reliability and availability investments. The hope that these investments will still be made despite neither market revenues nor forward markets support this outcome is unworkable.

For example, the analysis confirmed that a majority of the generators in ERCOT experiencing natural gas outages and derates during the storm relied on less expensive interruptible transportation and/or interruptible gas supply to fuel their operations, while those generators with more costly firm supply and transportation received delivered fuel that closely matched their nominations during the storm. Based on the lack of Revenue Sufficiency from ERCOT's energy only market design, generators made rational decisions to defer a wide variety of investments, from winterization to firm fuel supply and reliability investments.

The next most consequential contributor to reliability degradation is the relentless creep of interdependence between infrastructure sectors, which contributes to increasing the fragility of each system(s) and sets the stage for cascading failures across sectors. Interdependence occurs when the reliability of one sector is mutually dependent on the reliable performance of another sector. The water industry provides a unilateral, or one way, interdependence example. The loss of electricity led to the loss or interruption of water supply to customers, which led to the issuance of boil water notices to those customers. The industry simultaneously lost real time situational awareness and control of their water networks as SCADA (Supervisory Control and Data Acquisition) controls lost power and/or communications with operational controls and field sensors. The natural gas and electric sectors provide an example of a bilateral reliance and interdependence problem where two infrastructure sectors were mutually dependent on each other. The field level power failures experienced by the gas industry curtailed the fuel supply needed to fuel dispatchable power generators. Like market-based pricing and transition to renewable generation, interdependence between infrastructure sectors is not going away. The impacts of interdependence will continue to deteriorate reliability without action – but proactive steps can be taken. It can be mitigated, fragility improved, and reliability enhanced by implementing a series of actions that are

- 1) relatively modest in scale,
- 2) focus on enhancing reliability of ERCOT, and
- 3) mitigate the interdependence risk between critical infrastructure sectors.

The two remaining key contributors to reliability degradation work in more subtle ways. These two contributors include rules, policies and regulations that create negative impacts to reliability instead of enhancing them and a legacy ERCOT philosophy and culture that has prioritized low cost to the detriment of reliability.

### What does the potential solution cost?

This is a very complex issue that would require resources far beyond the scope of this report. However, a simplified approach<sup>4</sup> considered an existing capacity-based power market for an indicative answer. PJM is an Regional Transmission Organization (RTO) that originally included Pennsylvania, New Jersey, and Maryland. It was expanded over time to include all or parts of Delaware, Illinois, Indiana, Kentucky, Maryland, Michigan, New Jersey, North Carolina, Ohio, Pennsylvania, Tennessee, Virginia, West Virginia, and the District of Columbia. PJM is a capacity market RTO that they term a Reliability Pricing Model (RPM) operating in 13 states and DC in the eastern interconnect. PJM is a larger market than ERCOT. This simplified analysis considered the average capacity cost over

## Executive Summary continued

a 10-year period from 2011 to 2021 in PJM and adjusted this to the equivalent size of the ERCOT market. Over this ten-year period the amount would have translated to a total cost of \$14 billion. This equates to \$1.4 billion per year. This adjusted amount equates to ~4% increase in prices in ERCOT (a \$37B annual energy market in 2019) and is a relatively modest level of notional investment for improved reliability and resilience. This provides an indicative level of the relative reliability and resilience investments expected.

The value of reliability is overwhelming, and the actual costs of reliability are likely to be lower when implemented and market force brought to bear. There are five (5) network recommendations for focused improvements:

1. **Invest in black start generation to ensure reliable and fail-safe dispatchable back-up power.**
2. **Restructure regulatory flaws negatively impacting dispatchable generation reliability.**
3. **Mitigate growing interdependency between infrastructure sectors.**
4. **Prioritize reliability focused regulations and incentives and eliminate regulations that include the unintended consequences of creating negative impacts to reliability.**
5. **Replace process and model bias and failures and the narrow pursuit of short-term price reductions with a reliability and resilience driven culture and prioritization at ERCOT.**

These five recommendations are detailed in the Recommended Actions section that follows. Accompanying this network-focused report are sector-specific reports and recommendations of the actions and investments needed to enhance the reliability of the system.



# Recommended Actions

---

# Invest in Black Start capacity to ensure reliable, fail-safe back-up

## BACKGROUND SUMMARY

### How the grid manages supply and demand

The electrical grid system must continually be in balance with generation matching demand while maintaining transmission safety margins on a real time basis. There are two types of electricity generators. Dispatchable generators are controlled in their output and can be turned on and off based upon requirements of the system, including ramping up and down production output to meet those needs. Non-dispatchable, or intermittent, generators produce energy only when its input source of energy is available (when the wind is blowing or when the sun is shining) instead of when the system or market needs generation. Complexities are created from managing the constantly changing output of dispatchable and intermittent generation against a constantly changing market demand.

Dispatchable power generators are engines. An increase in the power load (demand) is accompanied by a simultaneous increase in the power supplied by the synchronous generators, generally by the governors automatically opening a steam or gas inlet valve to supply more power to the turbine. Each generator has unique abilities or limits with respect to its individual capability to increase or ramp up and decrease or ramp down. Gas turbine, geothermal and hydroelectric generators generally can respond faster than a coal or nuclear plant (thermal and design limitations). These sources can also be complemented by emerging sources of utility energy storage capacity (batteries, CAES, etc.,) which can also serve ramping needs of the system on a short-term basis.

Generators that are pushed beyond these limits may protect themselves and trip offline or be at risk of damage from trying to meet the change request. In modern grids once the generators are running and synchronized with the grid (their rotations are aligned with the grid), the ramping up/down is then turned over to and controlled by changes in the grid (automatic generation control—AGC). Control systems in power plants detect changes in the network-wide frequency and adjust mechanical power input to generators back to their target frequency (up or down). This counteracting usually takes a few tens of seconds due to the large rotating masses of the generators at each generation plant. Temporary frequency changes are an unavoidable consequence of changing demand. As a result, the grid system is constantly working to keep itself in balance. However, if there is not sufficient power, even for a brief period, then generator RPM and the frequency drops. Voltage, the rough equivalent of pressure in a pipeline system, may also be reduced during times of stress.

A generator connected to the grid acts like a car on cruise control. If you start going up a hill and the hill is not too steep you can maintain speed despite the higher demand or load on the engine. If the road is too steep, then the engine is unable to maintain the speed (the spinning power of the engine or torque cannot satisfy the demand) and the car slows down. If the combined output of all the generators cannot supply

enough power, then the frequency will drop for the entire grid. All the generators slow down just like your car engine on a steep hill.

The demand on most larger grids is composed of a large, distributed load. There are many individual sources of demand that offset rises and falls of other sources and this dampens the impact of demand changes on the grid. Load diversity is created because not all refrigerators and electric heat pumps in a geographic area are turned on at the same time. For example, assume that only 30% of the refrigerators and electric heat pumps are running at the same time in the neighborhood. This load is considered diversified and utility systems are designed around a diversity of loads. When power supply is lost, such as from load shedding or blackouts, restoring the system can be complicated due to the loss of load diversity. If the system is without power for too long, then load diversity is lost because when power is restored - 100% of all the lights, refrigerators and electric heat pumps want to turn back on at the same time. The increased market penetration of heat pumps for residential heating with supplemental resistance heating creates a unique winter demand challenge. When temperatures drop below a certain level, (typically 25-30°F) heat pumps lose their efficiency and often require supplemental electric resistance strip heating. Resistance strip heating works like the toaster and creates a high demand on the electric system. During extended periods of severe cold weather this supplemental resistance heating may act like an undiversified load on the LDC, simultaneously demanding power. Much of the load on the grid system is inductive load (including motors from elevators to refrigerators and air conditioners) and is sensitive to frequency and voltage instability may seriously damage this equipment if the voltage or frequency fluctuates too much on the grid. The system must maintain the balance of supply and demand along with voltage and frequency is required.

Equipment breaks the transmission system's ability to transfer power which may become limited due to thermal limits, voltage limits and dynamic stability limits at any given point in time. Weather and usage impact the system. 100% reliability for a complex network system such as ERCOT is an unachievable goal, but a worthy aspiration tempered with economic realities.

### What Causes the Grid to Fail and Force Rolling Blackouts?

Frequency of the grid system will vary as load and generation change. During a severe overload caused by tripping or failure of generators or transmission lines, the grid system frequency will decline, due to an imbalance between load and supply or generation. Rapidly changing mains frequency is often a sign that an electricity distribution network is operating near its capacity limits, dramatic examples of which can sometimes be observed shortly before major outages. Frequency protective relays on the grid network sense the decline of frequency and automatically initiate load shedding or tripping of interconnection lines, to preserve the operation of at least part of the network.



## Invest in Black Start capacity to ensure reliable, fail-safe back-up

### What Are Black Start Conditions?

This is critical to avoid a black start condition which is created when the entire grid goes down. Even with protective relays and breakers in place, damage to critical and highly specialized equipment would be expected. Few of these components are kept as routine inventory spares and some components are not and they may need to be specially manufactured. For example, a major auto transformer at a power plant or substation may require 12 months or longer to be fabricated, shipped, and installed at the site. Once any failed components have been repaired or replaced the grid system must be restored to service.

### Restarting the Grid

The concept of restarting the grid appears simple, but the reality is far more complex. Many safety and control systems will have been compromised in the shutdown. Each of these must be inspected and isolated. Generators have a great deal of rotating equipment, pumps, safety, and control systems that must orderly started up when returning the generator to service. In normal operations, the power plant relies on power supplied by the grid to start-up this equipment. Under black start conditions this is not an option. Large power plants must rely on black start generators for this energy source. Individual parts of the grid must be isolated to allow critical black start generators to assist in the start-up of major generators.

These black start generators are the ultimate backstop to the system and must be well maintained, highly reliable and able to operate under a wide range of conditions supplied by dependable fuel. With the grid completely out of service, one must reasonably assume widespread impacts to the natural gas system, compromising natural gas fuel supply. The critical importance of dual fuel capability for black start generators with sufficient fuel stored on site is obvious. If black start generators fail to start or have compromised fuel supply, they cannot support the restarting of the grid. Once the generators are back on-line end users on the system can be slowly brought back on-line, constrained by a lack of load diversity, creating higher than normal network loadings. There will be other complications that further complicate the return and restoration of the grid. With expected cascading damage following such a catastrophic event, the system could potentially take weeks or even months to fully restore.

### The Impact of Grid Failure

The loss of the entire grid is not something we ever want to experience. During Winter Storms Uri and Viola, ERCOT narrowly averted such an event. The entire state could have suffered without power for weeks or even months. The human, social and economic devastation of this catastrophic near miss cannot and must not be ignored. Imagine a situation where in a single moment everyone loses access to clean water, sewage, refrigeration for food, food itself, fuel for vehicles, medical services, lights, security systems, internet, and phone service simultaneously. All of it gone. It is almost unimaginable to consider what would happen if this condition lasted for weeks or even months. Pat Wood, the former chairman of the PUCT described these conditions as

being “equivalent to going back to the stone age” in nature.<sup>5</sup>

### Winter Storms Uri and Viola Black Start Generator Experience

A few details about black start generation experience during Uri and Viola. There are 13 primary black start generators (back-up generators – the primary fail-safe to the system) and 15 secondary generators (think of them as the equivalent of back-up generators to the back-up generators) for a grand total of 28 generating black start units. According to the Black Start Working Group Presentation to the Reliability and Operations Subcommittee on June 3, 2021: nine of the 13 primary black start generators experienced an outage during Uri and Viola or had forced outage or fuel problems and tripped offline and 12 of the 15 secondary generators had forced outage events during the EEA. This means that a total 21 of 28 (75%) black start generators had operational issues during the winter event. Seven of 32 outage causes were related to lack of fuel (the report does not provide the reason of the shortfall - supply, transport or contractual).

Eighteen of these 28 units have only a single fuel resource. The low utilization or capacity factors of black start generators make it uneconomic for these resources to procure 24/7 year-round firm transport for natural gas supply needed to ensure reliable and dependable fuel supply. Ensuring a reliable and dependable service from these units requires dual fuel capable generators with secure on-site fuel storage of at least 1 fuel source. ASCE Texas Section also believes that the interdependence risk between the natural gas and electric sectors will likely further complicate and delay black start generators from being to access reliable natural gas supply during a black start event.

### Black start condition is never an acceptable option

**Texas was less than 4 1/2 minutes from black start conditions on Monday morning February 15, 2021.** The most critical generation to avoid black start from happening if possible and to ultimately serve as fail-safe generators to help recover and restart the grid after a black start event failed to operate reliably on any industry performance metric. Black start emergency capability and reliability must never be compromised. Revenue insufficiency resulting in underfunding of the reliability and availability of these vital and critical last line of defense resources is not acceptable.

*Recommendations on next page*

## Invest in Black Start capacity to ensure reliable, fail-safe back-up

### Detailed Recommendations

Texas must provide consistent, reliable, and adequate funding of sufficient term to satisfy revenue sufficiency for the black start generators including the incremental capital and operating expenses to support the following reliability investments:

Require all black start generation to have:

- 1) Dual fuel capability with a minimum dedicated on-site fuel storage of 14 days running at 24/7 with regular best in class testing of this capability.
- 2) Winterization, reliability, and performance investments consistent with top decile, best-in-class performance.
- 3) Black start generation that is incapable of dual fuel service or unable to meet minimum top decile reliability and resilience metrics should be replaced, unless it is hydroelectric with sufficient storage if served by a reservoir or run of the river capacity for reliability.

ERCOT should expect to dispatch these units based upon the generator's on-site fuel resource during winter emergency periods. Winter emergencies create unique circumstance of coincident residential and electric generation demand that is fundamentally different than the conditions experienced during the summer.

**Note:** While the outcome is uncertain, some aspects of this recommendation are covered in the Emergency Conditions List<sup>12</sup>.



## 2 Restructure regulatory flaws negatively impacting dispatchable generation reliability

### BACKGROUND SUMMARY

The ERCOT energy only market structure prioritized low cost over reliability. This has led to chronic underinvestment in reliable generation and under-contracting for more costly firm natural gas fuel supply, transportation and other services such as market area storage needed to meet winter demand peaks from the natural gas industry. The energy only market structure created a predictable and known underinvestment from deteriorating economics that is directly responsible for the ongoing erosion of reliability from dispatchable generation. “There is a fundamental bidirectional linkage between reliability and revenue sufficiency in electricity markets. Reliability standards, which are defined by policy, along with associated administered pricing rules, can prevent prices from reaching levels that properly incentivize generators to produce during times of scarcity.”

The market design and supporting rules and regulations in place rely on the “hope” that potential periodic scarcity premiums would be sufficient to incentivize long-term reliability investments. There is ample evidence that this hope is unfounded. Generation was not required to invest in winterization, and it was left to each generator to make rational decisions concerning that investment. According to Wood Mackenzie, “...During the 10 years prior to 2021, ERCOT’s Energy-only market did not provide a meaningful signal for natural gas or wind generators to winterize.” During these ten years period since the prior major storm in 2011, market signals that generators rely upon to make investment decisions in an energy only market, did not support winterization economics.

The economic reality is that dispatchable generation that has been unable to earn its cost of capital in 9 of the last 10 years is also unlikely to invest in winterization, firm fuel supply, dual fuel flexibility or other reliability and resilience investments. Any market design built on the hope that these investments will be made when neither market revenues or forward markets support this outcome and when extreme short-term peak pricing was unable to draw incremental capacity to the market is a form of reliability gambling. The recent purchase of an almost new 6-year-old 758MW natural gas fired generator in Temple, Texas for ~ 50% of its replacement cost provides strong market confirmation of the energy only market design shortcomings. Market system design contributed in both short- and long-term ways to the winter failures uncovered by Winter Storms Uri and Viola.

There are additional challenges today and over the horizon. The growing dependence on less reliable, intermittent resources increases reliability risk and subjects Texas to a potential tipping point where load shedding with its overwhelming social and economic impacts will likely become a routine event absent change. In ERCOT, natural gas generators have a mixture of firm and interruptible transportation and supply contracts that vary by generator. Increased levels of cycling are increasing the financial risk of these firm commitments and will likely force some of those generators with firm transportation and supply agreement

to relinquish these fixed obligations. The changing nature of demand will also require new natural gas infrastructure to support this evolving operational need. Lacking underwriting commitments, these critical investment decisions are likely to mirror the experience of winterization and not get done. Increased cycling impacts O&M expenses and left untended will decrease the reliability of the generating units. Enduring the equivalent of financial starvation from a regulatory driven energy only market structure impairing both black start and dispatchable generation capacity is at the heart of a systemic blindness to the critical and essential importance of reliability.

A sustainable and resilient, reliability focused power market that compensates reliable dispatchable generation is required to support the reliability and resilience of ERCOT. Dispatchable generation can only be consistently reliable when there is sufficient revenue to support reliability and resilience investments, including commitments for firm delivered fuel supply (transportation, market area storage and commodity supply). Reliable dispatchable generation requires a market that recognizes the value of reliability and capacity. Fundamental changes in the market are needed to appropriately compensate dispatchable generation for reliability, independent of whether it is called upon or not on a given day. Predictable and reliable revenue sufficiency is required to support the long-term capital investment and operating expense to achieve the desired system reliability.

ASCE Texas Section recommends a market mechanism that rewards reliability, whether the unit is dispatched or not, balanced with reasonable electricity prices for consumers to replace the current flawed energy-only market, with subsidized intermittent generators, that solely depends on scarcity pricing to provide revenue sufficiency for reliability investments. This can be done with a hybrid reliability prioritized approach that enhances the existing energy-only market.

*Recommendations on next page*

## 2 Restructure regulatory flaws negatively impacting dispatchable generation reliability

### Detailed Recommendations

ASCE Texas Section provides a hybrid solution to enhance the current energy-only model with a reliability focused solution that addresses the failures of the legacy energy-only market. ASCE Texas Section recommends the creation of a Reliability Focused Power Market (RFPM) with the following attributes:

- 1) The RFPM would provide revenue sufficiency for reliability and dispatchability that include winterization, firm fuel supply, market area storage, reliability investments, dual fuel capability (as needed) and supporting infrastructure (upstream). These investments in generation would help underwrite investments in adjacent sectors.
- 2) Simple-cycle Gas Turbines should be supported through revenue sufficiency from the RFPM to convert to dual fuel capability with liquid storage capacity for secure winter peak availability and create further system benefits from fuel diversity impacts on marginal energy price and as potential supplemental resources to prevent a black start condition.
- 3) As an integral part of RFPM, the PUCT, consistent with TX SB3, must establish industry-leading operational and reliability metrics applicable to the generator, including weatherization, with financial consequences applied for failure to generate reliably during extreme weather events.
- 4) All generators must meet their bid commitment. An effective RFPM would implement new incentive and penalty solutions applied to all generators that miss their bid commitment or forecast (high or low) within certain transparent bands of tolerance with the penalties (for performance outside of the tolerance bands that should be borne by the generator that failed to perform in an approach consistent with cost causation, adjusted for reflective top quartile Forced Outage Rates.
- 5) Incremental intermittent generation is reaching the tipping in its share of the energy market and should bear the cost of negative reliability impacts on the system through a reliability standard that requires funding reliability payments to dispatchable generation within the system or provide complementary reliability capability with similar duration tenor.

**Note:** While the outcome is uncertain, some aspects of this recommendation are being addressed in the Emergency Conditions List.



# 3 Mitigate growing interdependency between infrastructure sectors

## BACKGROUND SUMMARY

ASCE Texas Section has identified two related actions that are increasing the interdependency between infrastructure sectors and contributing to reduced system reliability and sector resilience. We believe that these issues were material contributing factors in cascading failures across infrastructure sectors. Interdependence can be one-way, such as when the water industry relies upon the electricity industry, or it can be two such as what exists between the natural gas and electricity industries. Most legacy analysis has noted the reliance of the electricity industry on the natural gas industry, but failed to recognition that it existed in both directions and the natural gas industry was dependent upon the electric industry. There are two forms of interdependence.

The first form is Explicit Interdependence, where major reliance by one sector, such as telecommunications reliance on electricity is well known. ASCE Texas Section identified a growing complexity in infrastructure that they refer to as the second form of interdependence or Interdependence Creep. This occurs where individual decisions about integrating with another sector might not rise to a level of concern but when this one-off integration is repeated hundreds or thousands

of times the result creates a systemic issue. The increased reliance on electricity driven solutions by the natural gas industry for full and partial field electrification of production, controls, operations, electric trace heating, compression and storage is increasing the fragility of both sectors. The increased reliance on heat pumps with strip heating supplement increases the severity of the demand peaks during extreme winter periods. Public policies, regulations and business decisions that increase interdependency must consider and include the quantification of reliability considerations.

*Recommendations on next page*



### 3 Mitigate growing interdependency between infrastructure sectors

#### Detailed Recommendations

Interdependence will continue to increase and get worse without action. However, this growing risk can be mitigated through a multi-step approach:

The natural gas industry must harden critical natural gas infrastructure to help ensure reliable natural gas service (see above) that the electric industry, LNG markets and other consumers rely upon. It is ASCE Texas Section's belief that this should be considered a minimum cost of doing business. The Texas Railroad Commission (RRC) should take steps to:

- 1) Stop incremental issues: Implement new standards for all new upstream and midstream infrastructure to ensure minimum reliability and resilience standards for extreme weather events.
- 2) Address the legacy issues: Work with producers and midstream participation, develop standards and a schedule of prioritized investment(s) to upgrade and assist in funding if needed, existing production and midstream infrastructure for severe winter conditions.
- 3) Full and partial field electrification is causing step change increases in interdependence. Proactively mitigate growing interdependence through support of cyber secure microgrids and back-up power solutions at identified critical natural gas infrastructure locations. This may also require working with TCEQ to support environmental permitting priorities of critical essential infrastructure
- 4) Ensure that the energy only model of ERCOT does not negatively impact the higher reliability capacity market model of the natural gas industry at either the intrastate or interstate level. Like any customer, the electric industry should not be allowed a free ride on a system paid for by others. The generators must be required to pay for the quality of service that it requires and not rely on subsidization by the natural gas industry.
- 5) RRC should lead the effort in working with industry, ERCOT and the PUCT to develop contractual arrangements with the LNG industry that allow for the appropriate compensation of LNG plants to provide flexibility to temporarily redirect their natural gas for short term peak system needs during periods of extreme emergency to increase systemic reliability.
- 6) The RRC should work with telecommunication companies to ensure minimum levels of local communication reliability serving critical field and midstream infrastructure that is maintained and prioritized for service continuity.
- 7) The RRC should work with TXDOT to develop plans to ensure transportation corridors serving critical upstream and midstream infrastructure are maintained to ensure emergency access by staff and equipment to expedite restoration and repairs.

*Recommendations continued on next page*



### 3 Mitigate growing interdependency between infrastructure sectors

#### Other steps and reliability enhancements

- 1) Applicable critical infrastructure sector regulators must support individual infrastructure sectors to implement back-up solutions to their internal operational and control systems to ensure that operators maintain operational control and oversight of their systems.
  - Water and wastewater systems should consider as independent systems to maintain situational awareness and control of their systems and add back-up power and/or microgrids to critical systems.
  - The electric LDC systems should be required to provide for remote load shedding and control of all feeders at the full range of expected load loss levels.
- 2) ERCOT and PUCT to financially support dual fuel conversions of Black start generators and low load factor gas turbine peaking generators (see #1 and #2 above) to convert to dual fuel for interdependence mitigation in support of reliability and gain the benefits of fuel diversity positively impacting system prices.
- 3) Outage planning and return to service needs to be more proactively managed and scheduled to ensure that there are no coincident major outages scheduled above certain maximum thresholds. Routine planning would also have a running daily priority of return to service of plants on scheduled outages to facilitate action plans. Units in a maintenance outage, should be paid their emergency return to service cost (including remobilization) by ERCOT if required by ERCOT and notified to meet an anticipated emergency or severe weather event.
- 4) ERCOT and the PUCT should encourage increase utilization of back-up power and robust, cyber-secure microgrids, that reinforce and enhance the reliability of the grid.
- 5) Local Distribution Companies (LDC's) must prove their ability to remotely implement and manage a demand rationing scheme in the event of curtailments.
- 6) LDCs should be able to develop, own and operate microgrids outside of the rate base in competition with 3rd parties.
- 7) Work with PUCT to discourage reliance on paper-based reliability solutions. Restructure the Critical Load Filing (CLF) process to establish a relative priority order for each load and a requirement to ensure that the distribution entity has completed distribution control investments to properly support the CLF prior to acceptance of filing. The timetable should be such that these firm loads are not approved until they can be incorporated into ERCOT seasonal planning efforts. Specific critical loads should be identified for alternative reliability investments, such as microgrids and back-up generation that deliver reliability to the end user and the grid. The Critical Load filings can effectively decrease system reliability by increasing prioritized firm power demands and reinforce the misperception that CLF increase actual reliability levels.

**Note:** While the outcome is uncertain, some aspects of this recommendation are covered in the Emergency Conditions List<sup>13</sup>.



# 4 Establish a foundation of reliability-focused regulations and incentives

## BACKGROUND SUMMARY

Prioritize reliability focused regulations and incentives and eliminate regulations that include the unintended consequences of creating negative impacts to reliability. Regulations and market designs can negatively impact

reliability, or they can enhance systemic reliability on the grid system. There are regulatory structures that burden the grid and reduce reliability during periods of extreme demand. Subsidizing activities that result in negative impacts to reliability must be eliminated. Policies that enhance or contribute to reliability should be encouraged.

## Detailed Recommendations

ERCOT should:

- 1) Place the risk forecasting of short-term generation on all generators by developing a bid performance requirement with tolerance bands applied to all generators with economic penalties placed on each generator for missing their bid (outside of the tolerance band). These penalties could be used to reduce the effective cost for the reliability incentives.
- 2) Work with the PUCT to preclude returning end user demand (individual, microgrid, industrial, etc.) that places incremental demand on the system during peak periods and system emergencies unless approved by ERCOT.
- 3) Implement new System policies that prevent utility scale batteries from re-charging (consuming power) while ERCOT was load shedding and on the verge of failure from frequency deterioration and those battery solutions that were allowed to be net consumers of power during the EEA must be altered to prohibit such consumption unless required by ERCOT.
- 4) Work with the State to increase support and incentivize dispatchable renewable resources from biomass, waste to energy, geothermal, hydroelectric, and long-duration energy storage (> 24-hour duration).
- 5) Ensure a sufficient number of credit providers are accessible on an over the counter (OTC) basis and available 24 hours a day, 7 days a week during severe weather events to support the needs of market participants.
- 6) Work with LDCs to identify and plan for interdependence mitigation investments and process changes to ensure both systemic reliability and customer level reliability by mitigating interdependence risks. LDCs should be required to submit interdependence mitigation plans for its critical load customers to ERCOT and the PUCT prior to the beginning of seasonal peak load periods. Critical loads that are also essential infrastructure, like water and wastewater, should have minimum interdependence mitigation plans developed and implemented consistent with minimum reliability and resilience standards.

### Systemic problems of economic sufficiency of critical infrastructure

On a systemic basis we must consider reliability centric approaches to funding and maintaining infrastructure. This new approach to sustainably manage our critical infrastructure is required to maintain reliability and resilience and to be economically sustainable. The legacy approach of “run to failure” is far more expensive and it disproportionately impacts the most vulnerable members of our society.

This topic is complex and beyond the scope of this document. However, there are some lessons that can be taken from what happened in ERCOT. Lessons about what worked and what failed. There was ample historical evidence that indicated that the energy only model was not economically sustainable and resulted in underinvestment in reliability and resilience. These lessons can then be applied to other critical infrastructure, not only in Texas but beyond. There are four lessons for consideration:

- 1) Reliability and resilience are societal expectation in critical infrastructure.
- 2) Establish Revenue Sufficiency requirements to adequately operate and maintain critical infrastructure in an economically sustainable manner.
- 3) Confirming evidence of revenue sufficiency could be required for approval of material capital underwriting of both new and upgraded capital investments.
- 4) Periodic public reporting, independently confirmed, of progress towards becoming economically sustainable on critical infrastructure would be a transparent metric for measuring the management, stewardship, and economic health and viability of critical infrastructure.

*Recommendations continued on next page*



## 4 Establish a foundation of reliability-focused regulations and incentives

The ASCE *Infrastructure Report Card* has been a foundational tool to inform stakeholders and policy makers about the physical status of the major sectors of critical infrastructure across the United States. This has been a very effective tool to inform and educate the public and policy makers about essential infrastructure and where critical infrastructure requires major capital investment. Regulators, policy makers and industry leaders also need to develop an understanding of the substantial value created from ensuring that critical infrastructure is also properly supported and managed to ensure that it is economically sustainable operationally and from an ongoing maintenance perspective. A foundation of economically sustainable operations and maintenance will contribute to a more reliable and resilient system of critical infrastructure in the future.

Individuals and businesses should follow the seasonal and storm specific recommended risk mitigation steps developed and communicated by government and industry with sufficient time prior to the event to minimize crisis response.

Government and industry can benefit from understanding how H-E-B, LP built a culture that proactively took steps in superior preparedness in advance of the pandemic to prepare, manage and resource for the crisis. This aspect of proactively managing reliability and resilience in the H-E-B, LP culture should be fully embraced by ERCOT to be successful in its shift to a reliability prioritized culture.

The following table provides a wide range of issues, rules, and regulations that impact reliability and a relative scale of reliability impact.

**Poor** = damaging to reliability.

**Supporting** = provides action to support reliability.

**Prioritized** = provides reliability centered policies and approaches.

[See Table 1]

**Note:** While the outcome is uncertain, some aspects of this recommendation are covered in the *Emergency Conditions List*<sup>14</sup>.



**Table 1: Range of Policies and Issues that Impact Reliability**

Reliability Policy Matrix	Reliability Damaging Policy	Reliability Supporting Policy	Reliability Prioritized Policy
<b>Black Start Generation</b>	Inadequate capacity payment to maintain revenue sufficiency	Reliability investments to achieve top decile KPI performance. Require dual fuel capability and provide revenue sufficiency to support top 10% reliability.	Require dual fuel capability in all black start generators with 14-day 24/7 fuel supply stored on site.
<b>Liquid Fuel Conversion</b>	Low load factor black start generators reliant on a single fuel	Require dual fuel capability for all black start generators with min. 14-day 24/7 fuel supply storage on site with capacity payment for conversion & storage.	All simple cycle combustion turbine required to be dual fuel capable and compensated for storage and conversion in capacity payment. Evaluate dual fuel flexibility for portion of CCGT fleet
<b>Intermittent Generation</b>	Little or no consequences for intermittent reliability impacts	Economic incentives to manage daily production within tolerance of bids applied to ALL generation. Capacity payment to dispatchable generation for confirmed availability regardless of actual dispatch.	Supporting policy + incremental intermittent generation to require contracted dispatchable capacity to offset system for reliability impacts
<b>SCADA and Management Systems</b>	Most critical infrastructure lost its situational awareness due to electric system outages and lack of interdependence mitigation.	Require all incremental system solutions to include parallel management capability in event of telecom and power system failures for all critical & major systems	Require independent system outside of telecom and power system for field systems to ensure continuity of service and situational awareness.
<b>Microgrids</b>	Allowing microgrids to return to ERCOT during EEA	Robust cyber secure microgrids that can't return to ERCOT during EEA events and establish operating standards for microgrids to satisfy for grid connection.	Robust cyber secure microgrid. Access ERCOT during excess supply and supplement ERCOT during EEA events. Allow LDC's to own/operate microgrids
<b>Natural Gas Winterization</b>	RRC of Texas has no winterization requirements on natural gas production.	RRC of TX develop appropriate minimum winterization standard requirement to support industry reliability and resilience for all new production	RRC of TX develop appropriate minimum winterization standard requirement to support industry reliability and resilience for all new and existing production
<b>Seasonal Market Simulation and Simulator Exercises</b>	Focus on summer gaming and limit to ERCOT and governmental participation	Require seasonal market simulation with required participation across all critical sectors prior to start of season. Each market participant required to participate and be certified.	Reliability supporting policy plus development of a market simulator for routine testing and certification of operational participants
<b>Natural Gas Storage</b>	Lack of capacity payments undermines investment market area storage needed to reliably support variable electric demand	Encourage development of market area storage for electric generation through capacity payments that allow commitments by electric generation.	Require risk adjusted percentage of high deliverability market area storage to ensure minimum of 2 days of 100% fuel demand of gas fired CCGT.
<b>Dispatchable Renewable Resources</b>	Discourage participation in market by dispatchable resources due to energy only structure	Encourage dispatchable renewable resources from biomass, waste to energy, geothermal, hydroelectric, and long-duration energy storage (> 24 hour).	Offer premium value in market for dispatchable resources that are dispatchable. Hold to same performance standards for FOR and related metrics.
<b>Critical and Essential Load Management</b>	LDC reliance on paper-based system for CLF w/o supporting system controls installed and inability to implement load shed	CLF deadline and validation complete prior to and integrated with seasonal firm load forecast and acceptance by LDC that it can physically support the load.	Robust SCADA, relay and switching systems to support rolling load shedding. Prioritize critical loads, require back-up generation to serve minimum load level.
<b>Demand Side Management</b>	Allowing curtailable customers to return to service during EEA	Load focused DSM with industrial, commercial and office space (especially CBD areas with low storm occupancy) prioritized for load curtailment.	All customers included in DSM. Discourage heat pumps for residential unless strip heating supplement controllable by LDC DSM program.
<b>Utility Scale Batteries</b>	Allow batteries to recharge during EEA period. Allowing batteries to be net consumers of power during EEA	Prevent battery recharging when operating reserves drop below minimum-security levels. Restrict recharging during EEA except when authorized by ERCOT	Limit incremental short-term battery storage until LT (1 day +) storage (of any technology is available)
<b>Vegetation Management (VM)</b>	Various standards	Ensure proactive vegetation management across all T&D systems	Require proactive risk-informed VM programs coupled with condition-based management cycles to improve reliability
<b>EV Recharging</b>	Allowing recharging during EEA	Encourage off-peak recharging of EV through incentives like TOU rates	Supporting policy + allow grid to call upon EV battery resources during EEA
<b>LNG</b>	LNG is a significant & growing year-round firm gas demand reducing gas system flexibility.	Consider LNG peaking fuel supply stored on site of generator as alternative to liquid fuel conversion of GTs.	Create economic option with LNG terminals for short-term interruption during certain emergency events.

# 5 Prioritized a reliability and resilience culture and best cost approach

## BACKGROUND SUMMARY

The over-reliance and failure of a model driven culture was on display prior to, during and after Winter Storms Uri and Viola. Extended regulator-driven clearing prices set at its limit of \$9000/MWh despite a lack of incremental generator response, resulted in higher prices but not more generation. Forecasts, models, and expectations were materially inconsistent with reality. The subsequent response to the storm doubled down on this strategy with a fix the model solution approach to solving reliability shortcomings instead of candid discussions concerning areas that require fundamental re-thinking. This problem is compounded by a distinct lack of clear ownership and accountability for performance<sup>15</sup> that is a common element in the legacy ERCOT leadership internal self-reflection about the events and a focus on their cost vs. reliability of the system.

Reliability and resilience are not performance outcomes that can be inspected or audited into the system. Reliability must be integrated into daily operations like how a business successfully approaches safety. An updated report or model may provide new insight, but seldom does it fix reliability issues. It takes actions. It usually is complemented with physical infrastructure upgrades and processes. It takes dynamic thinking and willingness to question everything. If reliability and resilience is truly integral to ERCOT then training and gaming the system must happen far more frequently and include other industry players and government officials to reflect the reality of infrastructure interdependence.

## Detailed Recommendations

- 1) Conduct disaster simulation exercises that include all impacted critical infrastructure entities (natural gas, water & wastewater, telecommunications, transportation and governmental agencies), are needed to regular test and sharpen skills in response to system emergencies, identify process and risk areas. These should be reinforced prior to winter and summer seasonal periods. Seasonal focused gaming and training should be scheduled and completed **prior to** the beginning of the season. A system disaster simulator that includes interdependent sectors, like what has proven effective in training pilots and nuclear plant operators should be developed for ERCOT and include other interdependent sectors and encourage active training and experience between sectors by sector teams.
- 2) ERCOT should be periodically reviewed by an independent agency and benchmarked against leading independent system operators.
- 3) ERCOT must be held fully responsible for changing its processes and decision making to prioritize reliability of the system. This responsibility should not be diluted or delegated. The PUCT should be the entity responsible for holding ERCOT accountable for changes, metrics, and Key Performance Indicators.



# Network Report

---

The American Society of Civil Engineers (ASCE) represents more than 150,000 members of the civil engineering profession in 177 countries. ASCE is the nation's oldest engineering society, founded in 1852. As a public service, ASCE periodically prepares an Infrastructure Report Card (IRC) assessment of critical infrastructure serving essential needs on both a state and national level. The assessment is performed periodically on various critical infrastructure sectors (e.g., water, energy, roads, etc.) and provides a standard assessment approach of the physical condition and performance capacity of the various sectors of infrastructure. It is undertaken to educate the public and those in government who oversee such matters. ASCE released its most current national *Infrastructure Report Card* (IRC) in February 2021. The Texas Section of ASCE represents nearly 10,000 members throughout the State and released its state-level IRC in February 2021. Both IRCs follow a standard report card assessment. In addition, when a catastrophic event takes place and infrastructure fails, ASCE deploys skilled engineers from its membership to assess and determine what happened, its causes, and more importantly, to develop recommendations for future change, as appropriate, to avert such an event. ASCE Texas Section convened a task committee as Texans experienced Winter Storms Uri and Viola.

The impact of Winter Storms Uri and Viola on Texas and its energy system was catastrophic. The consequences for Texans were tragic. These impacts included at least 210 Texans who lost their lives during the storm and substantial and lingering economic impact to the entire region that is estimated to exceed \$200 - \$300 billion<sup>16</sup> in addition to the disputes and securitizations.

Even before power was fully restored, teams of ASCE Texas Section experts were tasked to understand what happened and why it happened. The ASCE Texas Section Beyond Storms Infrastructure Network Resilience Task Committee was formed. ASCE Texas Section discovered most of the physical infrastructure performed as anticipated given the severe circumstances. However, the team discovered more consequential failures in the manner the infrastructure was being used and the increasing risk of interdependence between infrastructure sectors that had reached a tipping point. Major reliability failures were exposed by Winter Storms Uri and Viola, but these failures extend well beyond the February 2021 storm itself and beyond the physical aspects of the infrastructure.

Some problems were directly due to the extreme weather event and independent of the electric grid. However, many other problems can be linked directly to the failure of the electric grid and certain other problems that were indirect in nature such as problems that were compounded or made worse due to the grid failure. A portion of the infrastructure failures were due to the extreme weather event itself. It is extremely difficult to determine if, for example, a pipe was already freezing due to weather and the loss of power was simply the final straw to what was already in the process of failing. However, ASCE Texas Section believes that the failure of the electricity grid was directly and indirectly a material contributor to the economic harm and human tragedy experienced during and after Winter Storms Uri and Viola.

Some of the energy-only market problems were new. Some of the problems have been lurking silently in the background and were exposed for the first time. Other problems have been festering issues that were known (and documented<sup>17</sup> in response to a weather-related EEA in February 2011) but remained unaddressed. **The urgency driving the need to solve these problems is simple –ASCE Texas Section understands that Texas was lucky. It could have been immeasurably worse.**

The market expects both reliability and resilience. In simple terms reliability is having access to electricity that you need when you need it. End users measure reliability in a binary way. The end user expects the lights to turn on at a flip of a switch. It is reliable and it works, or it is unreliable and does not work. As the dependence on electricity compounds due to increased electrification that reliability expectation will continue to intensify. Resilience is equivalent to the backstop to reliability. It complements reliability. Resilience is a measure of the robustness of the system to be able to absorb shocks and how the system either continues to operate or, if it fails, how quickly it recovers and operates again. Resilience requires physically stronger infrastructure configurations and the institutional resourcefulness to adapt and skillfully respond to operational challenges<sup>18</sup>. Neither can be achieved without adequate and consistent maintenance capital.

Texas has long been a leader in energy and innovation. The Texas electric grid has been in a constant state of reinventing itself to accommodate new technologies, grid expansions and satisfy growing demand since its formation. The current energy transition is creating additional and unique stresses to both reliability and resilience. In this transition, substantial federal and state incentives supporting new intermittent wind and solar resources have led to the dramatic growth of renewable energy resources in Texas. This current transition is well underway. ASCE Texas Section recognizes that the grid will continue to evolve and that the grid of the future will not look like today's grid. From a reliability perspective, this type of generation resource presents operational challenges that are fundamentally different from prior changes. These new renewable generation resources are considered intermittent generation because these generators rely on an intermittent, or changing, resources of energy (wind or sun) to produce electric power. Most of the legacy generation is termed dispatchable generation because the output of power is controlled by the generator (or grid) and allows a generator to ramp production up and down to meet system requirements. As intermittent generation power output changes unpredictably, dispatchable generation must make up the shortfall or compensate for the excess generation to keep the grid balanced, creating stresses to both reliability and resilience. It also created economic stresses that compounded the operational challenges.

Any energy transition must have at its foundation an expectation and requirement of even higher levels of reliability and resilience, especially given the current environment of increased electrification and infrastructure interdependence. Transition can never be used as an excuse for reduced reliability and resilience. The outcome of the February storm confirms that the legacy priority on the short-term benefits of low cost to the detriment of reliability and resilience was costly. ASCE Texas Section expects that new and changing rules will be thoughtful and effective and that any investments will be balanced in relation to their impact and contribution to reliability and resilience to produce a best cost outcome that prioritizes reliability and resilience at a reasonable cost. The recently appointed new ERCOT and PUCT leadership has been encouraging in their comments that they may view things differently going forward "...Historically our market (ERCOT) has focused on affordability first and reliability second...But now, reliability is first"<sup>9</sup>. ASCE Texas Section seeks to provide its perspective on the root causes of the Winter Storms Uri and Viola failures and provide recommendations to avert these risks in the future and support improved reliability and resilience in Texas.

### Weather Overview

Texas weather is influenced by three distinct geologic features the Rocky Mountains, the relatively flat central North American continent, and the Gulf of Mexico. The Rocky Mountains block moist Pacific air from the west and tend to channel arctic air masses southward in the winter, the relatively flat central North America allows easy north south movement of air masses, and the Gulf of Mexico is the primary source of moisture, most readably available to the eastern portion of the state.

From north to south, Texas measures approximately 801 miles from the northwest corner of the Panhandle to the tip below Brownsville. From east to west the State measures approximately 773 miles from the Sabine River to the Rio Grande just above El Paso. Covering an area of 268,597 square miles. The State ranges from sea level along the coast up to approximately 8,751 feet MSL. at Guadalupe Peak in the Guadalupe mountains. Due to Texas' vast area weather events and natural disasters are typical confined to local and regional areas. However, this is not always the case such as the drought of the 1950s and 2011 and winter weather such as February 23-20 (Winter Storms Uri and Viola).

### The Weather Event of Winter Storms Uri and Viola

During the period of February 13, 2021 and February 20, 2021 there were two winter storms that barreled through the state producing high temperatures that were below freezing, throughout the state for several days. Precipitation, in the form of snow, also occurred throughout the state.

Throughout this section the temperatures and precipitation discussion is based on the NOAA Climate Normal, 30-year averages from 1991 to 2020. For Texas, a few days prior to the winter storms, on February 8, much of the state experienced temperatures above the average maximum temperature, and average minimum temperatures were fairly normal. On February 9, 2021, the average maximum temperature began to decrease in the Panhandle and along the Red River. On February 10, the average maximum temperature was significantly below normal for approximately the north third of the state with the lower half of the state above normal. The normal average low temperature for February 10, 2021, was below normal for approximately the north half of the state and above normal along the Sabine River and the Rio Grande.

Moving into February 11, 2021 the normal average high temperature for much of the state was moderately to significantly below normal with the exceptions of above normal temperatures in the Sabine River, far west Texas, and lower Rio Grande area. The normal average minimum temperature was below normal consistent with the areas with below normal maximum temperatures.

The day before the Winter Storms Uri and Viola surged into Texas the average minimum temperatures in Texas ranged from near 0°F to 30°F from the High Plains, Edwards Plateau, South Central and East Texas. The Upper Coast, Lower Valley, Western Mountain, Southern and far East Texas recorded temperatures between 30°F and 40°F. The average high Temperatures from 10°F to 30°F in the High Plains, Edwards Plateau, South Central and into East Texas temperatures with an area in the western High Plains reaching as high as the mid-40s. The remainder of the state reached highs in the low 30s to the mid-50s, with the mid 50's in the Trans Pacos and Lower Valley areas.

In Amarillo, the temperature dipped below 40°F on February 8, 2021 and did not recover to above 40°F until February 20, 2021. Lubbock, Dallas, and Waco dropped below 40°F on February 9 and did not recover until February 19, 2021. Continuing to move south Austin and San Antonio dropped below 40°F on February 10, 2020. Whereas Austin recovered to above 40°F on February 19, 2021, temporarily recovered for a few hours on February 19, 2021, and made a fuller recover above 40°F on February 20, 2021. San Antonio temporarily recovered on February 17, 2021, for a few hours before dropping again to recover a few hours on February 19, 2021, with a fuller recovery on February 20, 2021.

Houston dropped below 40°F on February 12, 2021 and was slightly above and below 40°F during February 12 and 13, 2021 while dropping below 40°F on February 13, 2021 recovering, for a few hours on February 18, 2021, recovering above 40°F for a longer period on February 19, 2021 and fully recovering above 40°F on February 20, 2021. McAllen, the furthest south, had a significant temperature drop on February 11, 2021, dropping approximately 30° from 70° to 40°F in approximately 12 hours and dropping below 40°F on February 12, 2021, recovered to above 40°F for a few hours on February 16-19, 2021 and a full recovery on February 20, 2021.

In each of the temperature patterns shown below the diurnal patterns are significantly depressed. Looking at the Dallas, Waco, Austin, San Antonio records it can be seen on February 13, 2021, a second wave, Winter Storm Viola, swept through the State. In the I-35 corridor stations the weather record indicates a significant dip in temperatures into the single digits.

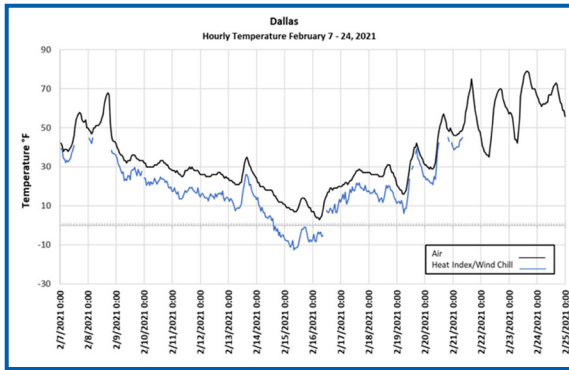

Figure 1: Hourly Temperature for Feb 7-24, 2021 for Dallas

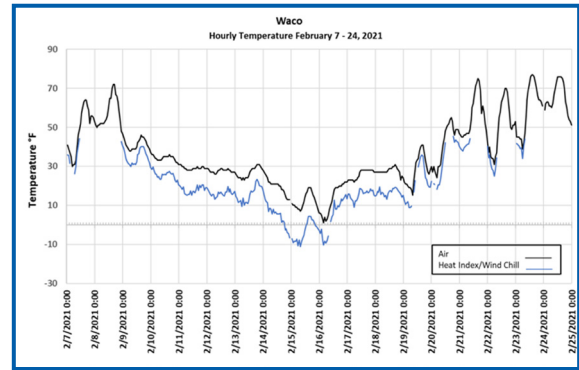

Figure 2: Hourly Temperature for Feb 7-24, 2021 for Waco

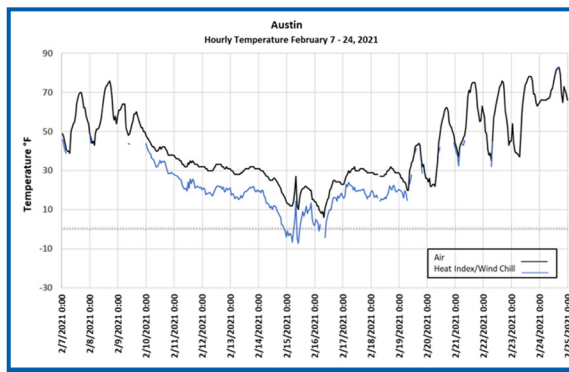

Figure 3: Hourly Temperature for Feb 7-24, 2021 for Austin

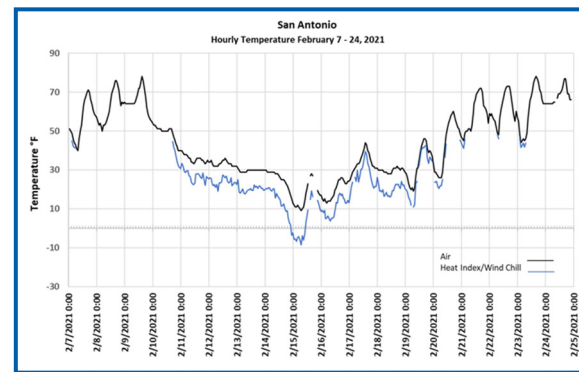

Figure 4: Hourly Temperature for Feb 7-24, 2021 for San Antonio

Hourly Temperature Summary (February 7-24, 2021)

Location	Consecutive hours below 40°F	Consecutive hours below 32°F	Minimum Temperature	Minimum Wind Chill Recorded
Amarillo	281 hours	236	-9.9°F	-26.22°F
Lubbock	234 hours	43 hours and 186 hours with 2 hours above 32°F between (reaching 35.1°F)	0.0°F	-17.45°F
Dallas	255 hours	70 hours and 138 hours with 3 hours above 32°F between (reaching 35.1°F)	3.0°F	-12.68°F
Waco	233 hours	206 hours	1.0°F	-11.06°F
El Paso	60 hours	38 hours	14.0°F	2.84°F
Austin	211 hours	162 hours	6.1°F	-7.2°F
San Antonio	158 hours	104 hours	9°F	-8.48°F
Houston	113 hours	41 hours	15.1°F	0.54°F
Mc Allen	90	16 hours and 17 hours with 6 hours above 32°F between (reaching 37°F)	21.9°F	7.69°F

Table 2: Hourly Temperature Summary (February 7-24, 2021)

Precipitation occurred in the southern half of Texas and in few areas of the Panhandle as well. The following maps will chronicle the storm based upon average daily Max temperature, average daily minimum temperature and average daily precipitation.

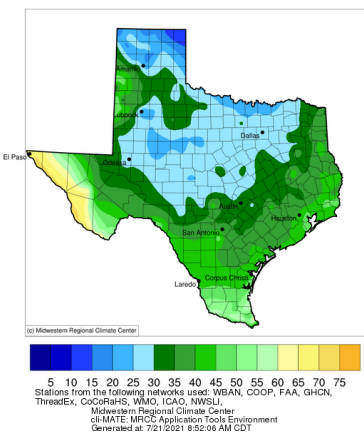

Figures 5: Feb. 12, 2021 Avg Maximum Temperature

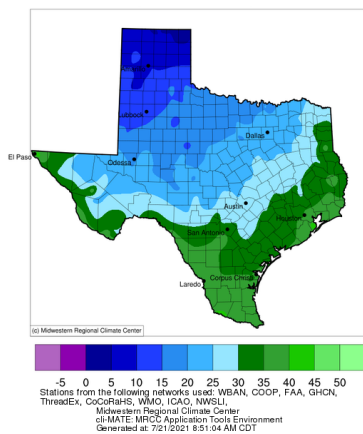

Figures 6: Feb. 12, 2021 Avg Minimum Temperature

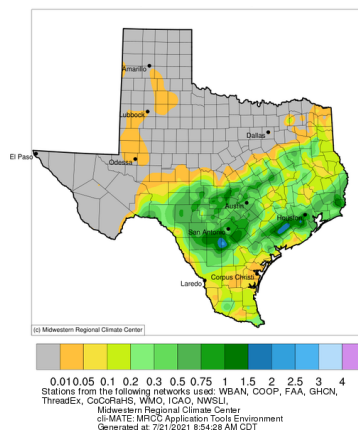

Figures 7: Feb. 12, 2021 Avg Daily Percipitation

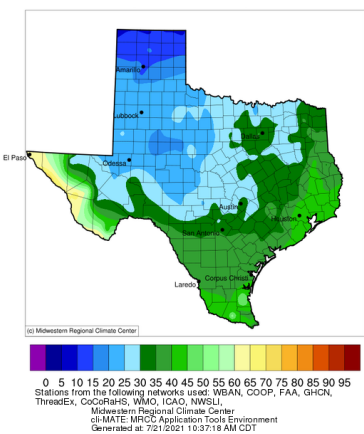

Figures 8: Feb. 13, 2021 Avg Maximum Temperature

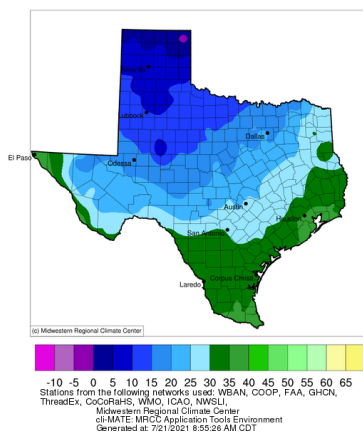

Figures 9: Feb. 13, 2021 Avg Minimum Temperature

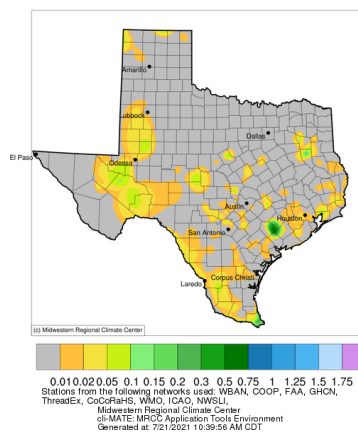

Figures 10: Feb. 13, 2021 Avg Daily Percipitation

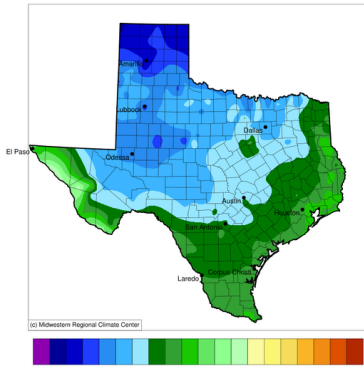

Figures 11: Feb. 14, 2021 Avg Maximum Temperature

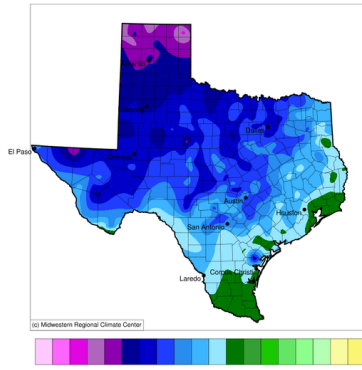

Figures 12: Feb. 14, 2021 Avg Minimum Temperature

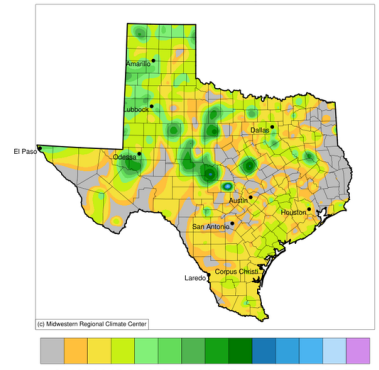

Figures 13: Feb. 14, 2021 Avg Daily Percipitation

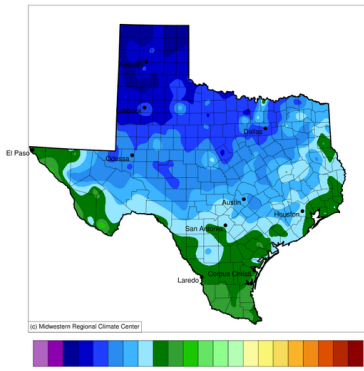

Figures 14: Feb. 15, 2021 Avg Maximum Temperature

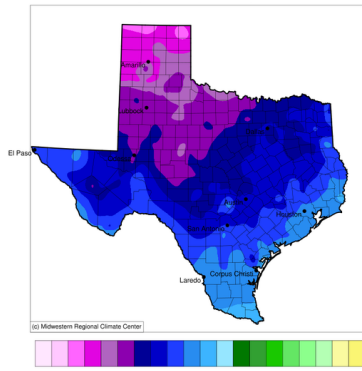

Figures 15: Feb. 15, 2021 Avg Minimum Temperature

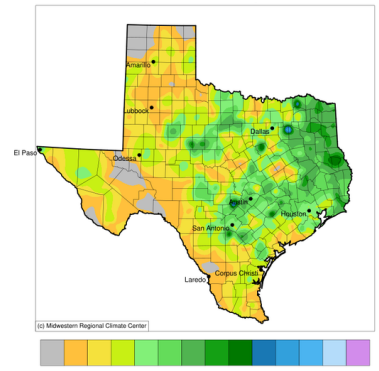

Figures 16: Feb. 15, 2021 Avg Daily Percipitation

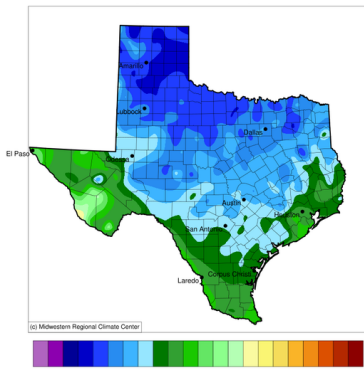

Figures 17: Feb. 16, 2021 Avg Maximum Temperature

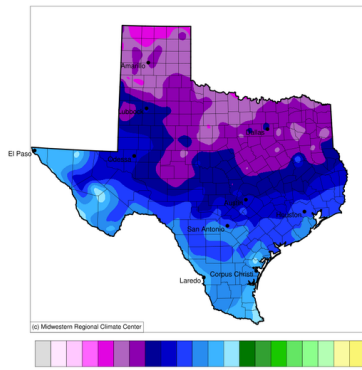

Figures 18: Feb. 16, 2021 Avg Minimum Temperature

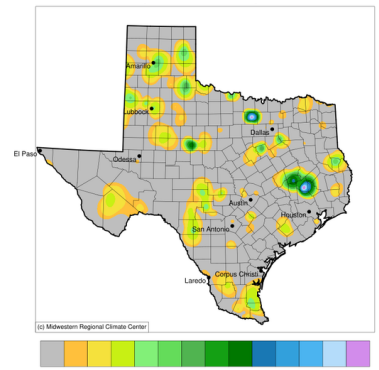

Figures 19: Feb. 16, 2021 Avg Daily Percipitation

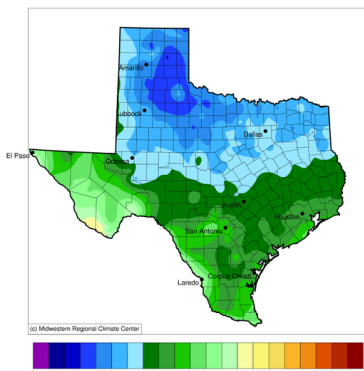

Figures 20: Feb. 17, 2021 Avg Maximum Temperature

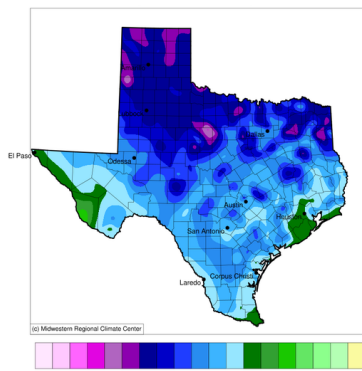

Figures 21: Feb. 17, 2021 Avg Minimum Temperature

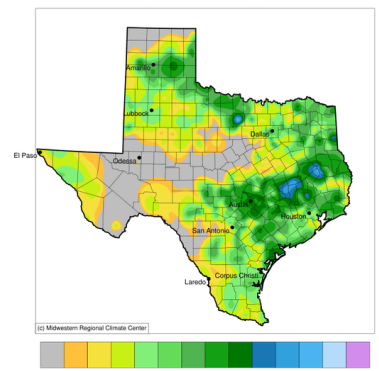

Figures 22: Feb. 17, 2021 Avg Daily Percipitation



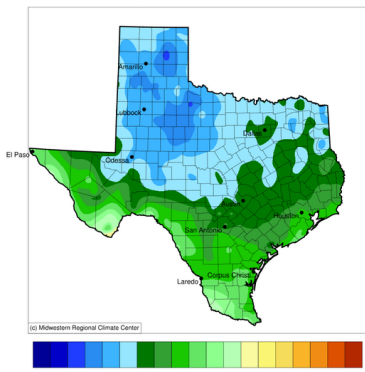

Figures 23: Feb. 18, 2021 Avg Maximum Temperature

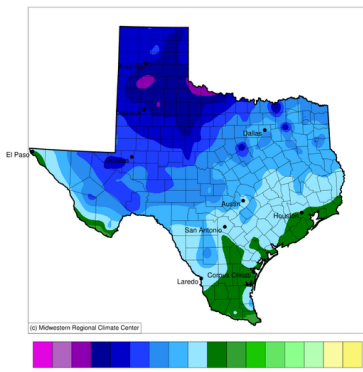

Figures 24: Feb. 18, 2021 Avg Minimum Temperature

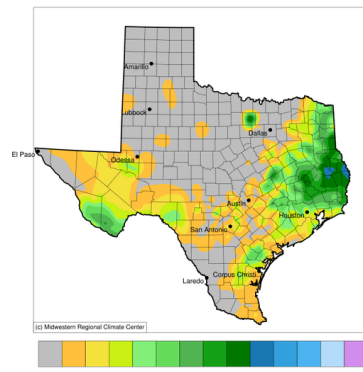

Figures 25: Feb. 18, 2021 Avg Daily Percipitation

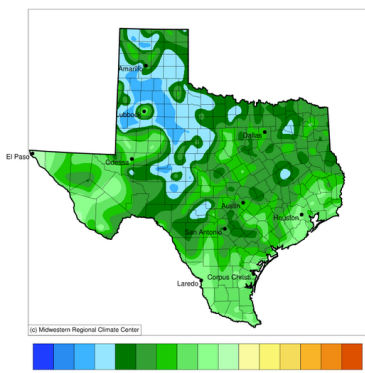

Figures 26: Feb. 19, 2021 Avg Maximum Temperature

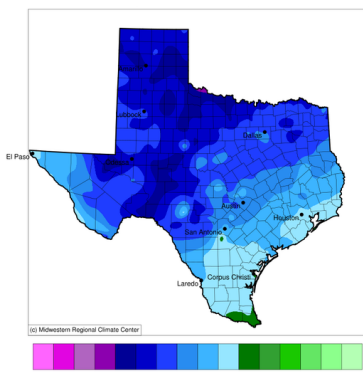

Figures 27: Feb. 19, 2021 Avg Minimum Temperature

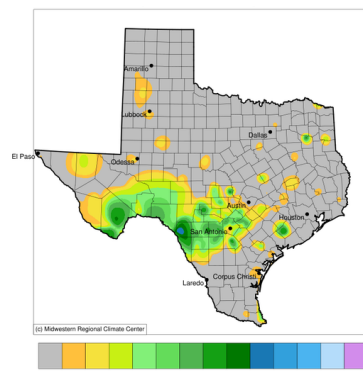

Figures 28: Feb. 19, 2021 Avg Daily Percipitation

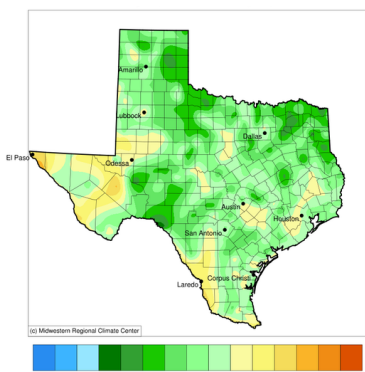

Figures 29: Feb. 20, 2021 Avg Maximum Temperature

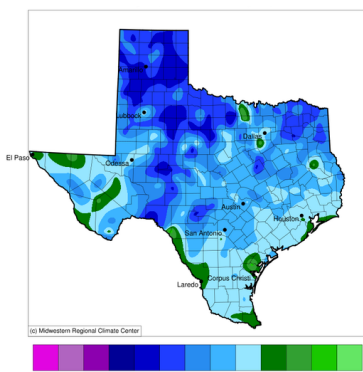

Figures 30: Feb. 20, 2021 Avg Minimum Temperature

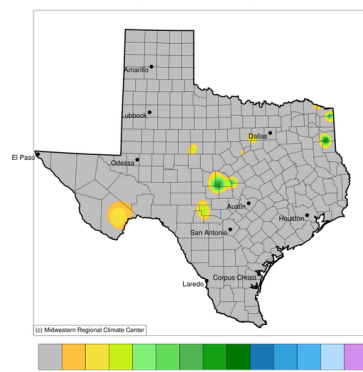

Figures 31: Feb. 20, 2021 Avg Daily Percipitation

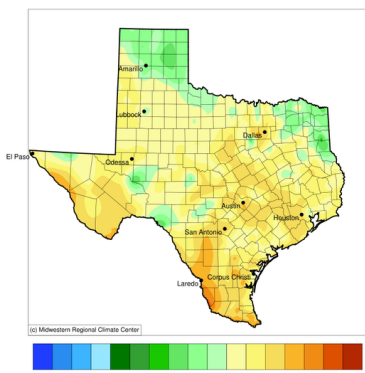

Figures 32: Feb. 21, 2021 Avg Maximum Temperature

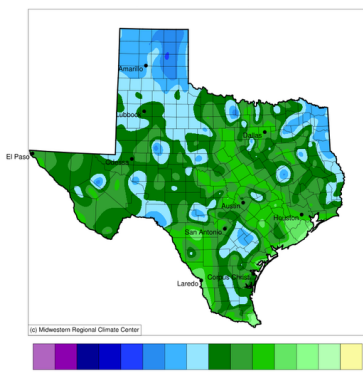

Figures 33: Feb. 21, 2021 Avg Minimum Temperature

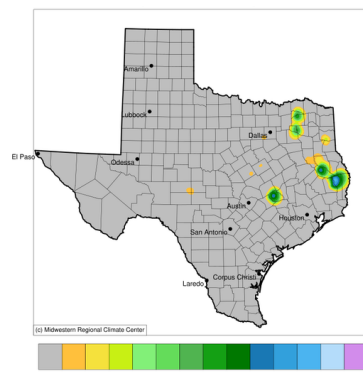

Figures 34: Feb. 21, 2021 Avg Daily Percipitation

### Macro perspective on weather

The weather event of February 2021 was severe. It was the first time in history that all 254 Texas counties were placed on winter storm warning. Fortunately, the physically damaging ice storms during Winter Storms Uri and Viola were localized in impact and wind was relatively moderate. Temperatures were not. Some experts have indicated that Uri and Viola were a 1 in 100 or 1 in 130-year system event. The severity of a winter storm's impact to infrastructure has four primary dimensions to consider:

- 1) **T-Max < 32°F** = the number of days when the temperature is below 32°F for the entire 24-hour period. This is the most important parameter of the four since it captures the core intensity of a winter storm and is a major contributor to infrastructure damage from ice formation (water pipes, controls, etc.).
- 2) **T-Min < 32°F** = the number of days on both sides of T-Max when the minimum temperature for at least 1 hour during the 24-period was below 32°F. While less of a direct impact than T-Max, T-Min can be thought of as factor that extends the impact of T-Max.
- 3) **Precipitation:** Precipitation has many forms from rain to snow. Snow can create problems in air handling systems and impairing road conditions in Texas. However, there is a band of temperature and precipitation conditions that lead to freezing rain conditions where rain freezes, turning into ice on trees and equipment, adding weight to trees and lines frequently contributing to significant physical damage of the infrastructure. This is the more impactful condition in Texas and this condition can be more severe by the final factor.
- 4) **Wind:** Wind creates two primary impacts on infrastructure:
  - Wind chill that accelerates cooling of key infrastructure components and
  - Increased physical damage to infrastructure when combined with precipitation – especially freezing rain. Example: transmission and distribution lines experience increased physical failures from ice and wind loadings, compounded by damage from similarly overloaded trees.

On a macro, Texas-wide basis, Winter Storms Uri and Viola presented extreme in T-Max and T-Min conditions relative to historic major winter storms in Texas. In comparison, the number of T-Max days experienced during Winter Storms Uri and Viola was last experienced in a January 1940 winter storm and the storm of 2011 had < 50% of the number of T-Max days of Uri and Viola. On the remaining two storm dimensions Uri and Viola were more moderate with respect to wind extremes and relatively localized on freezing rain precipitation.

The problem that ASCE Texas Section discovered is that too much focus on the storm distracts attention from the more critical issue. **Major reliability failures were exposed by Uri and Viola, but these failures extend well beyond winter storm events.** Texas has a substantial and growing electric system reliability and interdependence problem.

### The Initial Storm Response and Report Focus

ASCE Texas Section's initial observations of the storms' aftermath indicated:

**Power supply and transmission:** The physical transmission and distribution "wire" systems performed well, with limited failures under demanding circumstances.

- The limited areas of freezing rain precipitation and its associated icing conditions constrained what could have been a much bigger system problem. The outages were widespread due to a lack of power supply. Fortunately, the physical damage to the transmission and distribution grids were limited and localized in nature, facilitating service restoration once supply was restored and made available to the network.
- The management of the rolling blackouts following the initial load shedding was unevenly managed at best by the local distribution companies, resulting in highly uneven impacts of the outages.
  - Electric LDCs were inconsistent in their ability to remotely manage their distribution systems, especially as accumulated curtailments grew in scope.

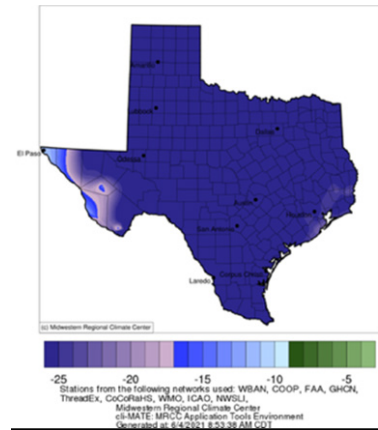

Figures 35: Average Maximum Temperature, Departure from 1991-2020 Normals (February 13 - February 20, 2021)

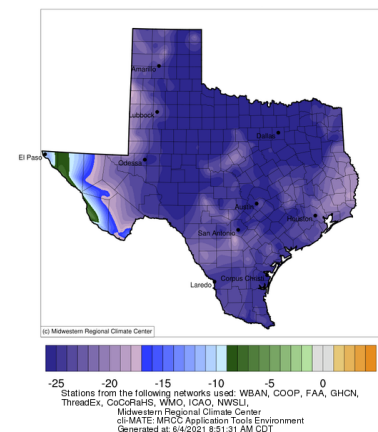

Figures 36: Average Minimum Temperature, Departure from 1991-2020 Normals (February 13 - February 20, 2021)

- The impacts from the failure by electric LDCs of distributing the curtailments evenly across customers combined with an inability to periodically rotate those curtailed customer groups contributed to extended blackout periods for some customers resulting in more negative impacts.
- There were a wide range of generator failures impacting all generation types from a variety of causes including weather.
  - There were an abnormally high number of scheduled outages for a storm that was forecasted 2 weeks prior.
  - Generation of all types failed to perform reliably when called upon.
  - There were fuel supply issues to power plants.

**Natural gas supply and transportation:** There were extensive impacts to the natural gas industry resulting in reduced production, treatment, and transportation of natural gas to customers.

- Natural gas storage was constrained at some locations by local power issues.
- There is anecdotal evidence that some infrastructure may have either elected to be curtailed in exchange for compensation or were asked by their local electric LDC to curtail their demand.

**Water, wastewater, and stormwater:** Drinking water systems were impacted by the loss of power to water distribution systems interrupting drinking water supply to customers followed by numerous boil water orders.

- There was the loss of situational awareness and system control from SCADA systems and local communications that were compromised by the loss of power.
- There were extensive water distribution pipeline breaks and countless water pipe failures in individual homes and businesses, both of which contributed to consumer property damage.

**Transportation:** Transportation problems from icy road conditions impacted the ability of critical infrastructure to deploy personnel into the field for identifying problems and effectuating repairs.

- With limited resources from widespread storm impacts, it was difficult prioritizing road treatments and repairs in support of critical infrastructure.

**Telecommunications:** There were telecommunication outages due to the loss of electricity and some localized areas overloaded by the reliance on cellular communication or the loss of circuits due to freezing precipitation.

The following high-level model highlights a portion of the interdependence between the water, telecom, natural gas, and electricity sectors. [See Figure 37]

### **General infrastructure and government:**

- There was a general lack of clear communication from industry and governmental agencies about the storm, its impacts, the steps individuals could take to be prepared for the storm, and actions that individuals should take in response to typical emergency conditions.
- Industry appeared less prepared for potential storm related outages that bypassed their ability to implement orderly shutdowns of processes.
- During the load shed events, neighborhoods were without power while many downtown business districts were empty but remained well lit.
- Critical infrastructure systems lost their operational awareness and control during the storm. For example: water systems reliant on grid supplied power lost their operational access and awareness of their systems and ability to remotely manage and control their system to respond to changing conditions.

The initial post storm response from industry participants, current and former regulators and other pundits were disappointing. Some of the information has been insightful, but much of the early information was defensive, parochial, and mostly self-serving. Most of the positioning appeared to blame another participant for the failure or was self-serving to try and take advantage of the situation. Others tried to discount away issues by claiming that the storm was “a unique weather event”. With this awareness in hand, ASCE Texas Section began its detailed review of Winter Storms Uri and Viola.

ASCE Texas Section became convinced during its early assessment stage of analysis that the answers to the February failures lay beyond our traditional physical infrastructure approach. Solving these issues demanded that ASCE Texas Section develop new insights and new ways to think about problems. As Thomas Edison reminds us “... we cannot solve our problems with the same thinking we used when we created them...”

Figure 37: Network Model with Interdependence

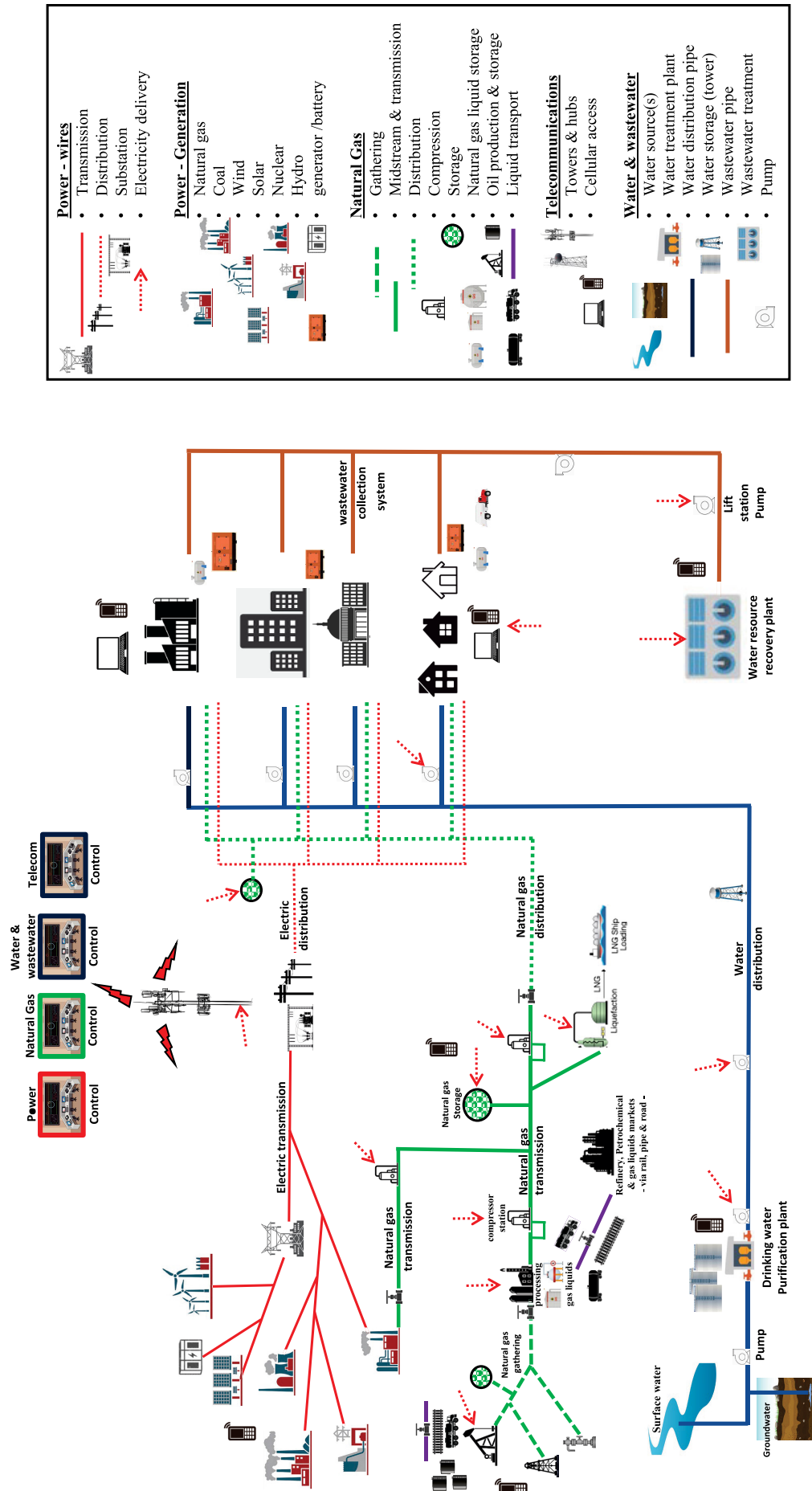

To solve the right problem, ASCE Texas Section needed to understand the context of how:

- 1) the physical infrastructure and our model of the physical world (digital twin),
- 2) the rules and regulations (including clarity concerning the ownership of responsibility for enforcing appropriate behavior), and
- 3) the operating market worked and failed during the storm to ensure that responsible reliability investments, changes, and recommendations are made.

Each of these legs also need to be predictable in how they work and interface or that variability will lead to instability.

For example, regulatory uncertainty increases the risk to long term investment decisions and adds instability to the stool. When the three legs of the stool are in harmony it creates a stable, reliable, and resilient market. When there is friction or conflict between these three legs, we create instability and lower reliability and resilience.

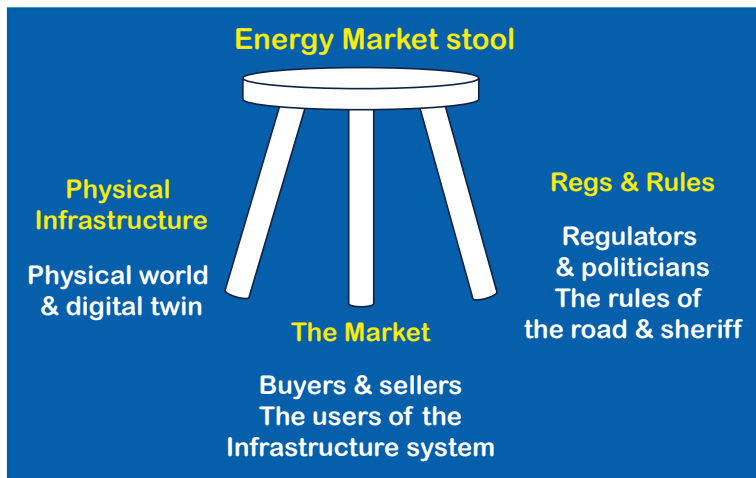

Figure 38: Energy Market Stool

**ERCOT overview**

The Electric Reliability Council of Texas (ERCOT) serves as an Independent System Operator (ISO), managing the flow of electrical power to 24 million customers in the state of Texas, representing approximately 90 percent of Texas’ electrical load. ERCOT operates a competitive wholesale electricity market, designed and overseen by the Public Utility Commission of Texas (PUCT). It is the primary entity responsible for ensuring reliability from a system composed of electricity supply from approximately ~710 generating units connected to more than 46,000 miles of transmission lines. Power is redelivered through > 5000 substations to Local Distribution Companies (LDCs) providers with distribution networks covering 200,000 square miles of service territory for delivery to the ultimate Texas end industrial, commercial, residential, and municipal end users.

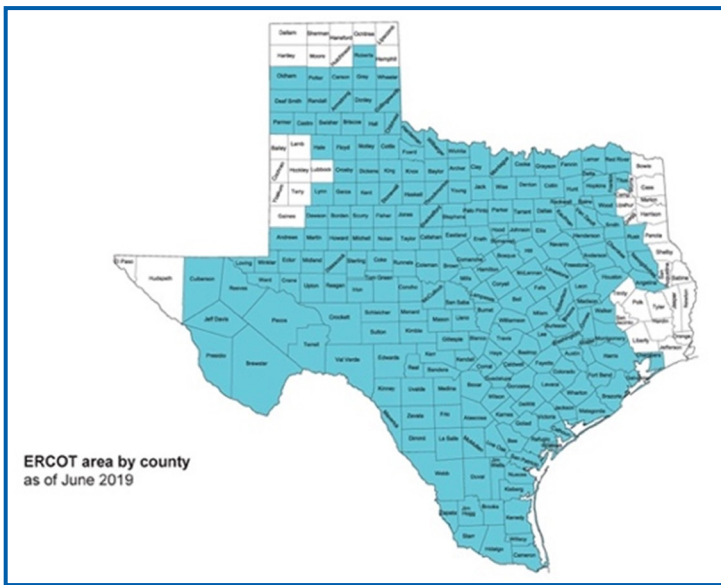

Figure 39: ERCOT area by county as of June 2019

ERCOT largely stands on its own and is considered an isolated or island grid, with limited interfaces (DC ties only) with other major grid systems. ERCOT would rank as the equivalent of the 10<sup>th</sup> largest country in global power production<sup>21</sup>, larger than many fully isolated and partially interconnected grids, like the UK, South Korea, Australia, New Zealand and even Japan (the Japanese market is larger than ERCOT, but it is split into two grid systems, one operating at 50 Hz and the second operating at 60 Hz with limited interconnection between them except for DC ties.). Each of these grids have proven that they can operate reliably in isolation. The nature of winter storms is that these storms impact the electricity markets of SPP to the North of ERCOT in a highly correlated fashion to when ERCOT is being impacted and to a somewhat lesser extent those markets to

the east (SERC) and west (SPP and WECC) of ERCOT. ERCOT’s grid isolation was not a material factor in its reliability performance related to the storm. There are some potential reliability and resilience benefits that could be achieved in the case of a black start event. However, ASCE Texas Section’s analysis is that much of that benefit could be achieved at lower cost by making the appropriate reliability and resilience investments to black start generation supplemented by dual fuel conversions of existing simple cycle gas turbines.

**How does an electric grid system work and what makes a grid reliable?**

The grid is a complex network operating system that connects electric generation (supply) to the market (demand) across a network of high and low voltage wire systems. This grid also interconnects with and either a) directly relies upon other networks such as the natural gas pipeline network for fuel supply or b) provides critical service to support other network infrastructure systems, like water and wastewater systems. There are four main components of the electric grid system:

- 1) the wires or T&D: Transmission (high voltage) and distribution (low voltage),
- 2) generation or supply,
- 3) the market, and
- 4) end users.

The electrical grid system must continually be in balance with generation matching demand while maintaining transmission safety margins on a real time basis. Complexities are created from managing the constantly changing output of dispatchable and non-dispatchable intermittent generation against a constantly changing market demand. In normal operating conditions, dispatchable generators are scheduled to be turned on and off throughout the day and when dispatched, these units are adjusting up and down within certain operational limits throughout the day.

Equipment breaks, conditions change and demand changes from what was forecasted. A key component to ensure a reliable system is reserve generation capacity. This is dispatchable back-up generation that is readily available to ensure that system is prepared to handle these changes as well potential contingencies (typically the loss of the two biggest electricity generator sources or major transmission lines). Reconciling natural gas dispatch with real time power dispatch requirements, emission limits, production variability from intermittent generation, and peak load periods (peak loads vary by season with a single afternoon peak during summer and a double winter peak in early morning and in late night) are all examples of further complexities in the power market. It is important to understand the differences between Planned Outages, where units are scheduled to be removed from service for repair and maintenance and Unplanned or Forced outages when a generating unit trips offline are other routine complications. Unplanned or Forced Outages along with other challenges described above can make the grid system unbalanced. Meeting these complexities require dependable, flexible and dispatchable electric generation resources.

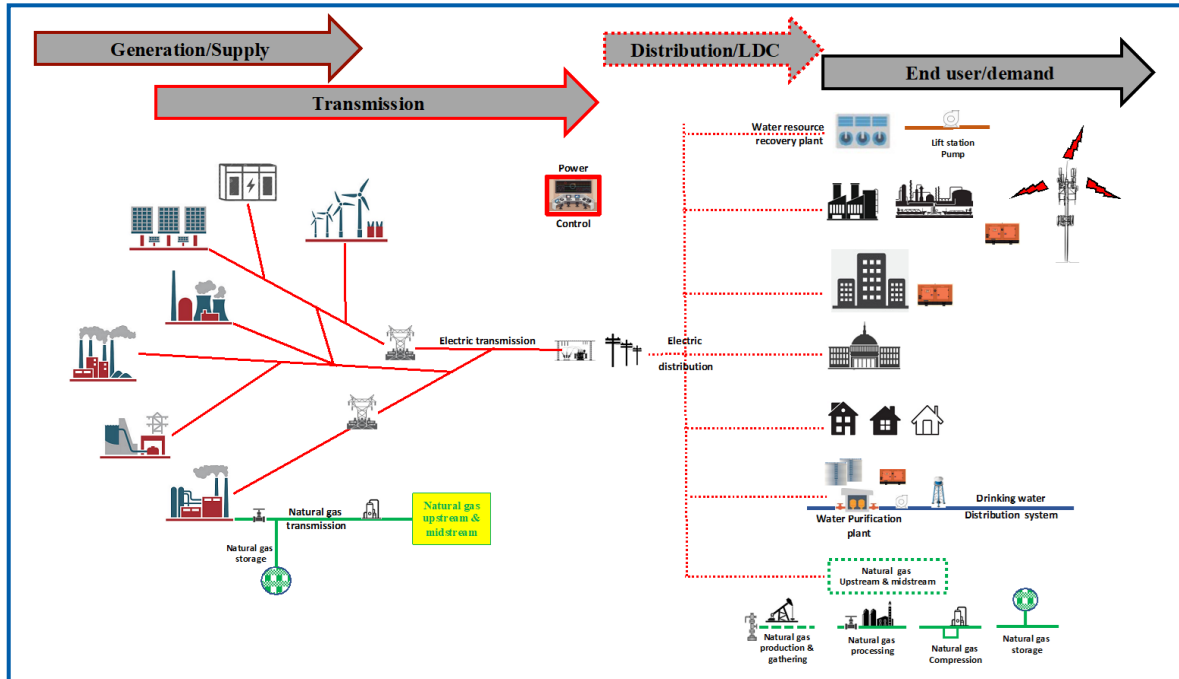

Figure 40: Electricity Physical Network model

To maintain system balance either the supply must be increased (more generation) or the demand must be decreased. If the supply capability is exhausted or otherwise incapable of responding, the system is forced to reduce demand by load shedding. To avoid catastrophic failure the system must immediately (within a matter of minutes) shed or drop load to curtail demand. One of the key triggers for system security is frequency deviation with respect to the 60Hz requirement. The worst-case outcome is if the system gets too far out of balance and the grid shuts completely down. During such an event it is likely some critical and hard to replace components will break in the process and grid must be restarted. These conditions, when the entire grid is lost and everything goes dark, are termed black start conditions. The complexity of restarting a grid in back start conditions could potentially last for weeks or even months.

### #1 The wires or T&D (transmission and distribution)

#### Transmission – high voltage

At the tailgate of a power plant, the voltage of the electricity generator output is stepped up or increased to high voltage for transmission to the market or demand center. The 46,000 miles of high voltage transmission lines in ERCOT are akin to a highway system for electricity. Transmission is generally to be lines that are 69kV and higher

voltages. Transmission lines allow for larger volumes of power to move around the system over longer distances. The transmission system links power generation, to distribution sub-stations where the voltage is stepped down or reduced to serve distribution companies and large industrial customers. There are currently > 5,000 substations in ERCOT. The system is economically dispatched. The system must run lower variable cost generation dispatched first, and then the next more expensive unit dispatched until the amount of supply plus reserve satisfies demand plus contingencies. Complicating this is congestion, the equivalent of traffic on the transmission highway.

One key distinction of transmission highways is that the electrons relentlessly seek the path of least resistance between its source of production and demand. This creates congestion on the transmission system, a situation where the load flowing across a transmission line exceeds operating parameters. Physical failure due to trees, ice or high winds can eliminate transmission pathways. Ambient temperature changes and dynamic changes in the level and location of supply and/or changes in the level of demand and where that demand is located also impact congestion. Generation is optimally located near load centers to minimize transmission and congestion issues. Intermittent generation is located near its source of supply (wind or solar) contributing to congestion and the need for major transmission expansions. Too much congestion makes the system unstable, increasing the risk of a reliability event. To avoid this condition the system operator may require changes to the dispatch order. Economically dispatched power plants are ramped down and more expensive power plants are ramped up to relieve the congestion. This out of merit (uneconomic) dispatching increases the cost to the consumer but is necessary for reliability of the system. In other situations, ongoing congestion problems may require transmission expansions to resolve congestion points and relieve reliability concerns. The \$5.9 billion CREZ transmission project to largely serve distant wind generation is an example of a congestion and reliability relief expansion project.

### Distribution by electric LDCs - low voltage

The transmission system transmits and re-delivers power to the distribution system where voltage is stepped down or reduced for local distribution companies (LDCs) to redeliver power to end users. There are thousands of miles of distribution lines serving customers in the 200,000 square mile footprint of ERCOT. The electric LDC takes responsibility on the output side of the transmission substation over their lower voltage wires to the end user electric meter. Some parties characterize the LDC wires as the “last mile” of a complex system to deliver power to the end user. There are two primary factors to transmission and distribution system reliability:

- 1) **Physical robustness** of the design, installation, and maintenance of the distribution system.
  - There are two types of primary failures:
    - Direct physical damage from extreme weather including lightning, high winds, and ice build-up (winter)
    - Indirect damage when the infrastructure is struck by an external source, like vegetation.
  - Physical damage to transmission systems often requires extensive time to repair due to specialized equipment and other factors.
  - Proactive risk-informed vegetation management programs coupled with condition- based management cycles are one of the most critical factors to physical transmission reliability and safety<sup>22</sup>. Vegetation’s impact on reliability as the leading contributor to distribution system outages requires proactive ongoing vegetation management programs. These programs are also usually the single biggest portion of annual T&D maintenance costs.
- 2) **Operational robustness** – fit for purpose and its utilization serving generation and demand within the constraints of the market as well as the rules and regulations.
  - This also includes robust cybersecurity of the systems and its controls. This is especially true of the transmission system since even minor impacts can bring major consequences.
  - This includes the distribution system’s ability to remotely monitor and manage emergency operations, including rolling blackouts.

## #2 Generation

The market for generation in ERCOT is considered “competitive” in nature which means that it is not economically regulated on a cost of service basis, like traditional utilities. There are a variety of owners of generation of different types. There are two primary types of generators on the ERCOT system:

- 1) **Dispatchable generators** are those that control their output and can be turned on and off based upon demand and the needs of the system, including ramping up and down production output to meet those needs. Examples include natural gas, nuclear, coal, geothermal, biomass and hydroelectric. Storage resources, like batteries are also generally considered as a dispatchable resource but are non-generating since it does not independently generate electricity, but purchases electricity from the grid.

- 2) **Non-dispatchable**, or intermittent, generators produce energy only when its input source of energy is available (when the wind is blowing or when the sun is shining) instead of when the system or market needs generation. This is largely composed of wind and solar resources.

The distinction between these sources of generation is critical in determining resource adequacy when considering the reliability and resilience of the system. Resource adequacy is simple in concept – is there sufficient generation capacity to meet demand at a future point in time? In practice the answers to this question are built upon a complex set of reliability-based analysis techniques.

Generally, a non-dispatchable generator is usually located near where its respective energy resource is the richest. During the past 20 years the location of new renewable generation capacity in Texas has reflected this trend and has expanded in the southern, western, and northwestern areas of the state where wind and solar conditions are more favorable.

Dispatchable electric generators tend to locate closer to load centers and their fuel supply is brought to the plant location. The location of new dispatchable plants in Texas have largely been developed in and around major load centers. Each dispatchable power plant is usually composed of several individual generator units. Each dispatchable generator unit has its own unique start-up/response criteria and ramp rates up/down to increase and decrease output. They are fueled by natural gas, coal, nuclear, water (hydro) and biomass fuels. A number of these plants use their fuel as a primary energy source to heat water and convert it to steam to drive steam turbines and generate electricity. Natural gas GT and CCGT consume the fuel directly (with heat recovery in CCGT) to drive turbines to generate electricity.

According to the EIA, ~28% of the total natural gas fired generation capacity in the US is dual fuel capable. Most of this capacity can consume either natural gas or oil (mainly distillate or residual fuel oil). Historically, a majority of Texas natural gas fired steam generation was dual fuel capable with the ability to consume either natural gas or oil. This provided important flexibility and reliability benefits to the system. According to EIA, Texas has the largest fleet of natural gas fired generation capacity (~69GW) and well ahead of California and Florida (~40GW each). However, at only 9%, Texas fuel flexibility ranks behind Florida, New York, and North Carolina in dual fuel capacity despite having a much larger gas fired fleet than these other states. Florida's natural gas generation fleet has maintained dual fuel capability in ~50% of its natural gas generation fleet. Dual fuel flexibility enhances reliability, and it also provides the economic benefit of alternative pricing to mitigate price volatility when relying on a single fuel source. Texas has allowed this flexibility option to deteriorate.

ERCOT has ~710 different generators located across its transmission system and ERCOT dynamically manages the output, ramp rates and availabilities of each of these resources against the needs of the system and constantly changing demand. The system also includes 28 black start generator units (primary and secondary) which provide fail-safe system back-up. Most are thermal generation resources complemented by a few hydroelectric resources. These generation resources are unique and critical in what they provide to the system and the catastrophic outcomes that they can help mitigate. Please see Recommended Actions #1.

There is a fundamental conflict between a market design that claims to value reliable service but fails to compensate generators for the capital investments and procurement of services and supplies required to provide firm service. Firm service from a generator usually requires that generator to be designed and maintained as a high availability generating unit. Fuel supply is usually acquired on a firm basis and shipped on firm transportation contracts (uninterruptible). Fuel security may be supplemented with access to firm natural gas storage or dual fuel capability that allows a plant to continue to operate using a different fuel if the primary fuel is interrupted or unavailable.

Intermittent generation is attracted to energy only markets because these generators are given a free ride for their lack of reliability and negative impacts to system resilience and are not financially disadvantaged by being intermittent and may in fact capture higher margins than similar intermittent plants that operate in capacity markets. This energy only margin is incremental to the federal subsidies (\$23/MWh<sup>24</sup>) that intermittent generation also enjoy from Out of Market subsidies. Costly transmission upgrades, like the CREZ project, was built to largely reduce congestion for incremental and existing wind resources. This is an ERCOT example of local subsidization in addition to the federal subsidization. These combined subsidies are sufficient to allow intermittent resources to generate income even in negative pricing periods due to the benefit of Production Tax Credits (PTC)<sup>25</sup>. Some market solutions address this uncompetitive situation by having generators compensated at the lower of bid or an adjusted marginal system cost that considers subsidies. Other markets assign the cost of transmission upgrades to the applicable resource or user. In contrast, dispatchable resources, critical to ensuring system reliability, are subject to the commitments they make to the system and the consequences of failing to meet those commitments.

Dispatchable generation has various fuel supply sources. They range from coal to nuclear fuel, water (hydro), natural gas and oil and biomass. Coal supply is usually stored on site (there were instances of fuel freezing in the piles) or the plants are located adjacent to their fuel supply (mine mouth). Nuclear units are refueled during multi-month cycles. Hydroelectric plants are subject to the run of the river or the storage level of the water reservoir. Biomass, a small contributor in Texas is often located near its source of fuel (ag waste, landfill gas, etc.). Natural gas fuel supply



is different, and it composes the single largest fuel source of dispatchable generation in ERCOT. It was also heavily impacted during the storm. Since fuel reliability directly impacts generation reliability, this next section focuses on natural gas supply issues.

**Natural gas fuel supply**

The majority of dispatchable generation, especially cycling generation, in ERCOT is fueled by natural gas<sup>26</sup> (dispatchable generation during 2020 accounted for ~ 74.8% of the energy provided composed of natural gas (39.77% CCGT and 5.89% GT), coal (18%), nuclear (10.89%), hydro (0.17%), and biomass (0.09%). There are generally three ranges of operations for dispatchable power plants:

- 1) Base load generally means that a plant is being dispatched >50% to 100% of the time. Nuclear plants and many coal plants are typically designed and dispatched as base load electric generators, and
- 2) Cycling generator units are usually dispatched between 20% to 50% of the time. Peaking units usually are dispatched for short periods of time often well less than 20% of the time.

These units are often simple cycle gas turbines that are short notice generators that start and shut down quickly and they are usually less efficient than cycling and baseload units. Understanding natural gas fired generation requires an understanding of how the natural gas industry provides fuel to power plants.

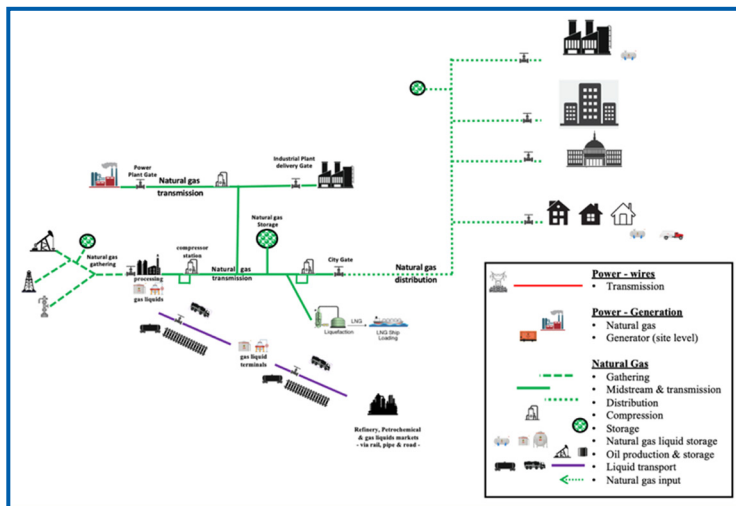

Figure 41: Physical natural gas, oil, and natural gas liquids model

The natural gas industry is a **capacity-based market design** that operates fundamentally differently from the **energy only design** of the ERCOT system. There are two components required for service to the end user or burner tip: gas supply and transportation service to move the gas from the wellhead to the burner tip. Both components have at least two different service quality levels from firm to interruptible service quality. Firm Supply (FS) and Firm Transportation (FT) cost more than interruptible services. The end users that have customer choice make the decisions concerning the quality and reliability of service that they need. The reliability of the service is a critical aspect of their decision. FT service contractually reserves a portion of the physical capacity of the pipeline and that capacity is held for the benefit of that transportation customer whether they use the service or not. The transportation customer pays fixed costs (take or pay – whether they use the service or not) for the firm capacity in the pipeline plus variable costs for actual incremental services consumed.

Interruptible transportation which as the name implies provides interruptible transportation service that is less expensive but also **less reliable service**. The generator purchases and pays for the interruptible transportation service only when it was needed and if it was available when needed. This distinction is critical in understanding how reliability between the electric and natural gas markets is approached very differently.

An MIT report noted the inherent resilience of the national natural gas transmission and distribution industry. “... The natural gas network has few single points of failure that can lead to a system- wide propagating failure. This contrasts with the electricity grid, which has, by comparison, few generating points, requires oversight to balance load and demand on a tight timescale, and has a transmission and distribution network that is vulnerable to single point, cascading failures ...”<sup>27</sup>

Each generator makes individual decisions about their quality of the fuel service and transportation that it requires. Peaking generators usually cannot procure annual FT and firm supply due to the costs that must be recovered during very short dispatch periods. Natural gas supply (the commodity) for electric generation is acquired separately from transportation in a bilateral marketplace where buyers and seller come together and negotiate the terms and conditions of the supply and related services, such as market area storage. The buyer determines the quality of its gas supply service to complement its transportation decision. Firm supply (FS) may include liquidated damages to protect the Buyer from supply failures and is sold as a premium service and is usually accompanied by fixed fees and minimum obligations. Some sellers may offer a bundled delivered fuel supply product.

In Texas there is a mix of firm and interruptible supply arrangements to generators. Mixed contract types (firm and interruptible) may not be broken out sufficiently in reporting and it may be unknown if the buyer adequately confirmed that firm supply is also supported by a supply chain of firm transport and firm supply sources upstream of the buyer’s transportation receipt points.

According to the November 2021 FERC-NERC report on the matter:

“...Natural gas pipeline capacity is for the most part designed, certificated and constructed to accommodate firm transportation commitments, while many natural gas-fired generating units rely on non-firm commodity and/or pipeline transportation contracts...”<sup>28</sup>

	ERCOT		MISO		SPP	
	Generators	Percent	Generators	Percent	Generators	Percent
Firm Commodity/Firm Transportation	45	24%	10	32%	47	33%
Firm Commodity/Mixed Transportation	14	8%	7	23%	19	13%
Firm Commodity/Non-Firm Transportation	0	0%	0	0%	4	3%
Non-Firm Commodity/Non-Firm Transportation	26	14%	1	3%	24	17%
Non-Firm Commodity/Mixed Transportation	9	5%	0	0%	13	9%
Non-Firm Commodity/Firm Transportation	1	1%	3	10%	14	10%
Mixed Commodity/Mixed Transportation	34	18%	5	16%	0	0%
Mixed Commodity/Firm Transportation	35	19%	0	0%	0	0%
Mixed Commodity/Non-Firm Transportation	0	0%	0	0%	0	0%
Did not provide information re: commodity contract type	10	5%	0	0%	11	8%
No contract or did not provide information about transportation contract type	11	6%	5	16%	9	6%
<b>Total</b>	<b>185</b>	<b>100%</b>	<b>31</b>	<b>100%</b>	<b>141</b>	<b>100%</b>

Table 3: Contractual Arrangements of Natural Gas-Fired Generating Units that Experienced Outages and Derates in the Event Area

The analysis continues to confirm that the majority of natural gas nominations (scheduled to ship on the pipeline) for firm transportation across the larger ERCOT/MISO/SPP geographic area confirms indicate that the overwhelming majority of generators with firm commodity/transportation service received (shipped) natural gas supply that closely matched their nomination (scheduled) supply levels. The analysis does not identify root causes for why generators failed to procure firm supply and/or transportation, if there were administrative issues that impacted firm service (failure to adjust to primary receipt points, etc.) or any other factors driving procurement decisions.

Increased cycling of electric generators will increase the financial risk of those generators with FT and FS services since these costs must be recovered in a shorter period of time. In addition, the incremental infrastructure required, such as market area storage, to support an increasing cycling demand is more expensive. This becomes even more important with the increasing percentage of firm natural gas demand being introduced by LNG demand growth and industrial demand growth coincident with residential winter demand peaks. Historically, electric generation’s summer peak focus avoided considerations of competing residential demand (winter peaking) or the impacts of year-round firm growth from LNG demand. Lastly, low load factor peaking generators that cannot economically support year-round FT and FS commitments need on-site fuel supply to serve peak demand periods.

During Winter Storm Uri and Viola, the Texas Railroad Commission temporarily re-prioritized how loads would be ranked for service in Texas<sup>30</sup>. This emergency order re-ranking amounted to a regulatory taking from those pipeline customers that were forced down lower in relative priority. As a result of re-prioritizing natural gas transport and supply to electric generation, the RRC’s actions effectively took firm transportation and supply contracts purchased by other natural gas users by prioritizing service to the electric industry that may have failed to choose and pay for their own firm transport and supply. This regulatory taking resulted in reducing reliability of the natural gas system to its other customers that had paid a premium for the higher quality service for the very purpose of ensuring that they had reliable service during the same period.

The natural gas industry is regulated differently than ERCOT, and the natural gas market dispatches its system during different time periods (gas day 09:00 – 08:59) than the electric market (calendar day of 00:00 to 23:59).

Even the physics are different. Natural gas moves through pipelines at ~12 miles per hour while electricity moves at the speed of light. The electric system must constantly remain in balance between supply and demand on a real time basis. The natural gas industry must also remain in balance, but over much longer periods of time. Pipelines have a limited ability to buffer changes in demand in their systems. Operators can increase the pressure of their pipelines, allowing more natural gas to be stored in what is termed “line pack” of the pipeline.

Further in the same report, FERC-NERC indicate:

“...the majority of natural gas-fired generating units experiencing outages and derates had a mixture of firm and non-firm commodity and pipeline transportation contracts or had interruptible transportation contracts for their contracted volumes. A minority of natural gas-fired generating units had both firm commodity and firm transportation contracts for all their contracted volumes...”<sup>29</sup>

This data confirms that only 24.3% of the gas fired generators in ERCOT that experienced natural gas outages and derates had contracted for the required combination of firm supply and firm transportation services to ensure firm service to the generator.

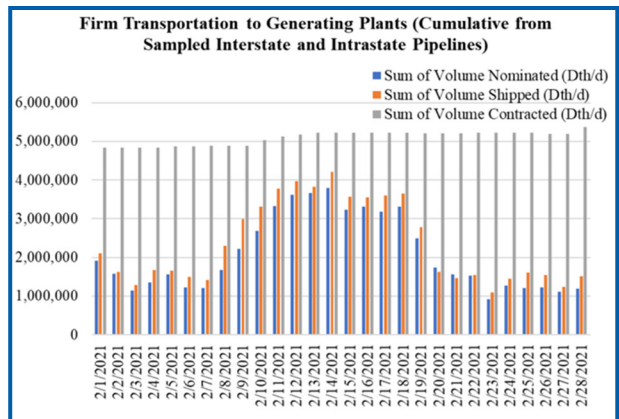

Figure 42: Firm Pipeline Capacity that was Nominated Shipped and Contracted by Natural Gas-Fired Electric Generation < February 1-28, 2021 from Sampled Pipelines in Oklahoma, Texas, Louisiana, and Kansas (units: Dth/d)

In the natural gas market, a single molecule of natural gas may change ownership multiple times between the wellhead and the burner tip as buyers, sellers and traders balance their portfolios at various trading hubs. An individual producer may trade natural gas volumes that far exceed their equity production volumes by aggregating supply from other sources.

One of the chronic issues with the energy only model is that it fails to recognize the value of dispatchable capacity and the fixed economic commitments required for firm fuel supply and transportation, which typically have annual fixed cost commitments required for these generators to be reliable during peak demand periods. The energy-only model contributes to a reduction in the reliability of gas fired generation that is rationally driven to interruptible fuel supply and transport.

Other sources of electricity supply also had performance issues during the February storm event. Utility scale batteries essentially procure power from the grid to recharge their cells and then store the electricity until it is then bid into the system and the electricity discharged.

Apex CAES developed an analysis summary, issued in July 2021, concerning utility scale battery performance during the Energy Emergency Alert (EEA) indicating that there was a material mismatch between what batteries claimed they provided during the EEA and what they provided.

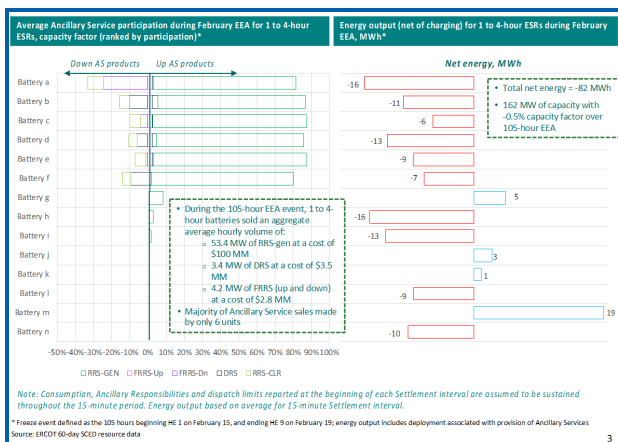

Figure 43: A subset of new ESRs participated in ancillary markets during the EEA, but failed to supply energy needed to maintain reliability

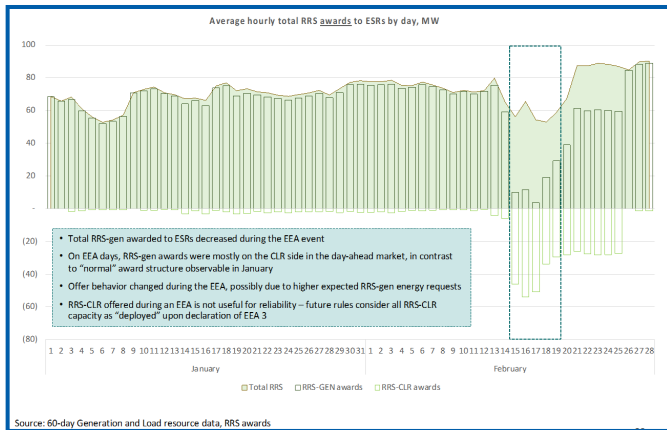

Figure 44: In contrast to January, ESRs were awarded substantial RRS-CLR during the EEA - This offer behavior ultimately resulted in charging

It appears that their likely pursuit of incremental revenue and regulatory and rule arbitrage resulted in their failure to provide energy needed to maintain reliability. During severe periods of the EEA event "...batteries provided little energy and had charging load".

There are certainly operational circumstances when such behavior is supported by the needs of the ERCOT system, but this should only be the outcome when ERCOT makes such an election.

### #3 The Market

ERCOT operates as an energy-only market with real-time, day-ahead, and ancillary service markets composed of bilateral and centralized transactions. ERCOT also performs financial settlement for the competitive wholesale bulk- power market and

administers retail switching for 7 million premises in competitive choice areas and serves in the role of a balancing authority in the market.

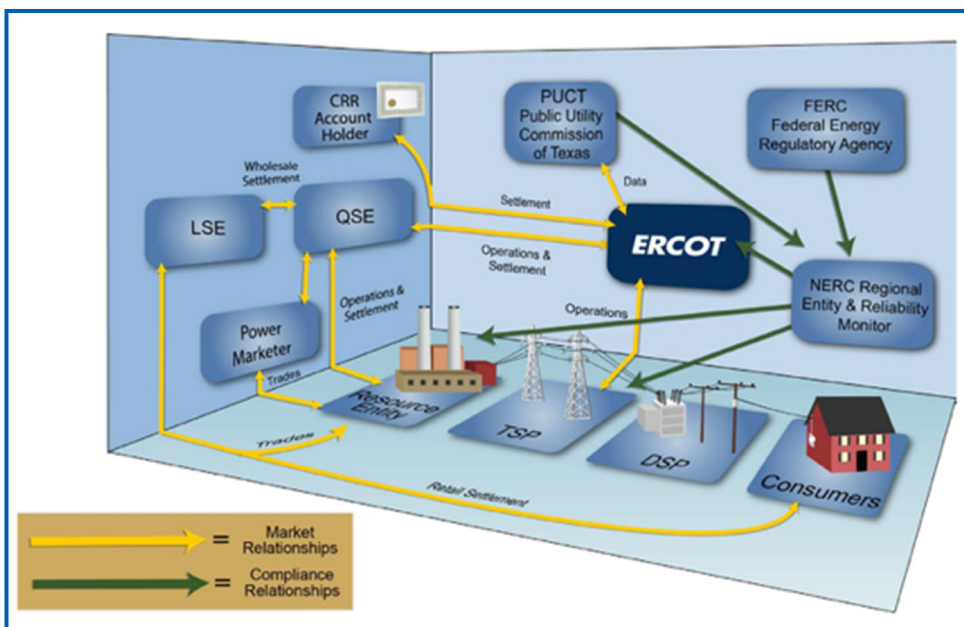

Figure 45: ERCOT Compliance Relationships

ERCOT has a complicated set of relationships for compliance. Note that FERC’s relationship is only indirect through NERC given ERCOT’s physical isolation from other states and therefore is not subject to FERC regulations. This is primarily handled through the PUCT.

In an energy-only market a generator is compensated only when it generates. In theory the objective is to try and recover the costs to build generation with revenue from energy production and operating reserves. There is limited price differentiation between dispatchable and non-dispatchable generation despite the fundamental differences impacting reliability, although there are incremental ancillary service revenues available when dispatched. Furthermore, with high fixed and low operating costs, subsidized non-dispatchable generation diminishes margins in an energy only market for the dispatchable generators. In a perverse outcome that negatively impacts reliability and resilience, non-dispatchable generation negatively impacts the economics of dispatchable generation critical for a reliable and resilient system.

**How does the ERCOT market work – a simplified overview<sup>31</sup>:**

The ERCOT market is relatively complex and a detailed review of the various aspects of the market are beyond the scope of this project.

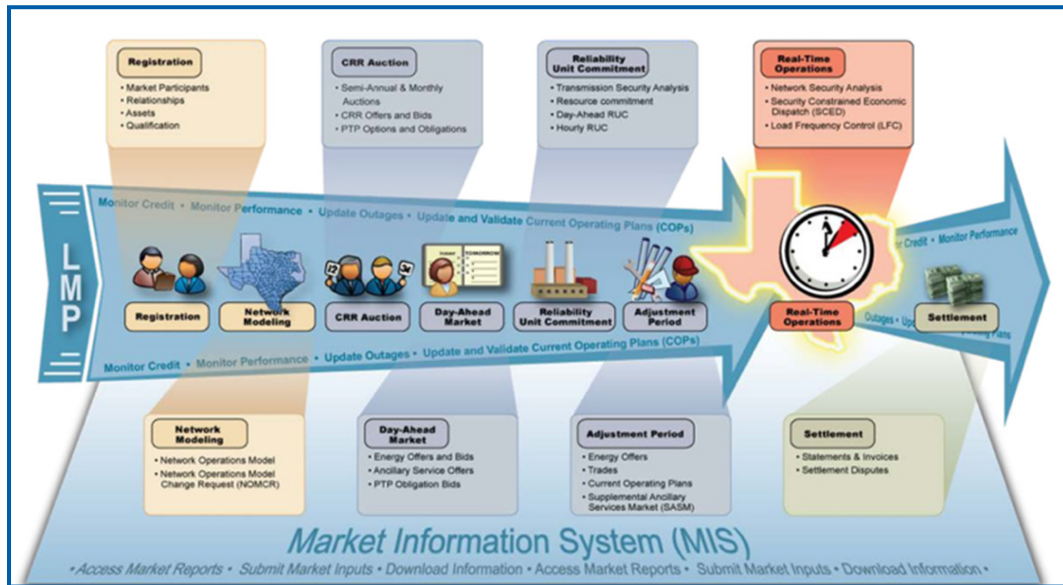

Figure 46: ERCOT Wholesale Market

While described as a “market” there are many observers who question the validity of this description given the deep reach of the regulator into the market, routine changes in policies and the material impact of federal and state level subsidizations of certain generation sources participating in the market and skewing market prices. For the purposes of this project, ASCE Texas Section will use the market reference.

Some key components to understand about the energy-only model:

- Generators only earn money when they generate.
- The day ahead price is determined based upon the marginal price of energy in the system being dispatched at a given point time (see generation and transmission sections).
- Regulators in turn allow prices to rise well above fixed and variable costs as an incentive to generators to make incremental capacity investments
- The periods of very high prices are termed as periods of “scarcity pricing”. The scarcity pricing mechanism (TX Admin code section 25.505), which also has an overall cap on prices.
- The price cap is set at one of two levels, based upon the PNM or Peaker Net Margin. This regulatory mechanism tries to balance the needs of the generator to make sufficient margin balance against the desire of low price to the end user.



Figure 47: ERCOT Day-Ahead Market

- PNM starts each year set to \$0 and increases during the year depending upon market prices.
- There is a threshold level for PNM. System-wide offer cap is set at the High Value Cap (HCAP) until the threshold level is achieved. If the threshold is met, then the system-wide offer cap is reset to the Low Value price cap (LCAP).
- In simple term, unless the market prices have been sustained at levels above an administered level (theoretically where the generators have met or exceeded revenue sufficiency), then the market is left with a higher super peak cap to try and make up for sustained lower price periods.
- How are these HCAP and LCAP levels set?
  - It is administratively determined by ERCOT with the PUCT using various economic analysis and Monte Carlo simulation to try and determine price levels that support capacity reserves margins of 10-15% to prevent blackouts. Refer to later section on reserve margins.
- Generators also have potential earn fees for providing ancillary services
- There are other pricing impacts including transmission constraint management (Locational Marginal Pricing or LMP and congestion - these are location specific), real time scheduling, settlements, reserve price adders (value of reserves ERCOT wide).

#### #4 End users: the value of reliability to the market

Competitive marketplace buyers are offered choices. Choices are about their provider, the types of products, service levels and price. These decisions are delegated to the end user in both the natural gas and electric markets. The end user “owns” both the liability and the benefits of their decisions. There is a portion of the retail market served by LDCs where the LDC assumes this responsibility for the end user. This is predominantly smaller household level customers. In some structures this is referred to as the provider of last resort (POLR). Competitive markets have consistently proven their superior ability to routinely provide innovative products and services. They are dynamic and produce substantial value. However, complex markets supported by critical infrastructure create unique circumstances for consideration. Energy only market designs fail to capture any value for reliability to the end user. In contrast to the natural gas capacity market design that explicitly values reliability and resilience, the energy only electric market design is different.

**Reliability and resilience are not explicit choices**, but they are essential and expected outcomes. ERCOT’s middle name is “Reliability” and end users implicitly relied upon ERCOT to ensure reliability is being managed for their behalf because end users could not take steps to ensure this function themselves.

Some large end user participants may lack the capabilities (these capabilities include qualified personnel, governance or oversight and supporting infrastructure (systems, reporting, etc.)) required to be informed market participants and either naively assume this risk away or ignore it.

Caveat emptor, let the buyer beware, as a philosophy fails to work when the costs of poor decisions are borne by everyone in the marketplace because less informed market participants seek to be bailed out for their bad decisions. Policy must be clear concerning where this responsibility resides and those individuals with responsibility should be held accountable, just as a vehicle operator that fails to buy collision insurance must pay if they are in an accident. The problem has been that ERCOT has been the driver, but the entire market has been accountable for the risk exposure.

#### How do we consider risk, reliability, and resilience?

This next section reviews and compares three primary sources of reliability standards and performance, including US Department of Energy (DOE), the North American Electric Reliability Corporation (NERC) and The Electric Reliability Council of Texas (ERCOT). There is a great deal of specific acronyms and nomenclature used by the electric industry throughout this section. ASCE Texas Section worked to try and balance the details enough to tell the story, but not overwhelm the reader with details.

#### The DOE developed a risk landscape model in its approach electricity industry risk<sup>29</sup>

The energy sector is accustomed to framing threats to the electricity system in the language of risk, which is often expressed as the interaction between the likelihood of an event occurring and the severity of its consequences.

DOE has developed a conceptual model of the risk landscape to assist in developing priorities of focus.

For example, black Start conditions may be extremely rare as probability events, but the consequences (outcome) are extremely catastrophic in nature on almost any metric scale. In contrast localized vegetation driven distribution failures occur more frequently; the impacts are highly localized and usually of short duration. DOE has eight (8) areas of risk weighting factors to consider:

1. **Probability of occurrence** – How frequently are threats and/or consequences experienced?
2. **Extent of damage** – How critical and/or costly are the consequences?
3. **Uncertainty** – How much confidence can be associated with estimates of risk?
4. **Geographic extent** – how large an area are consequences experienced?
5. **Persistence** – Over what duration are consequences experienced?
6. **Delay** – What is the latency between the threat and the consequence?
7. **Reversibility** – To what extent and/or how quickly can affected systems recover?
8. **Social impact** – What is the potential for damage to human and societal well-being?

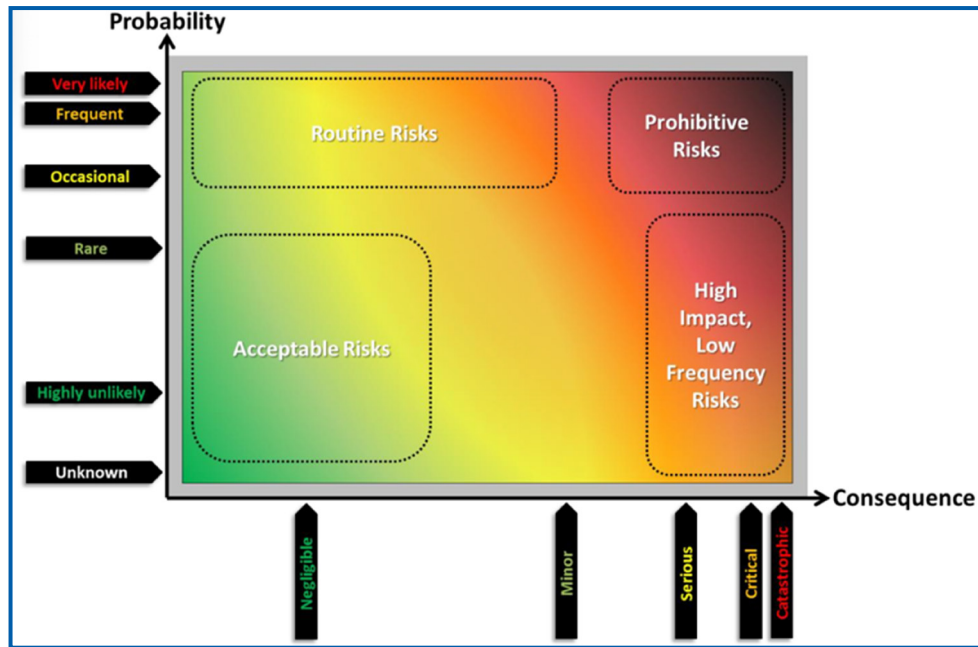

Figure 48: Conceptual Model of the Risk Landscape

**NERC uses an adequacy and operating reliability approach to analyze reliability**

North American Electric Reliability Corporation (NERC) is a not-for-profit international regulatory authority whose mission is to ensure the effective and efficient reduction of risk to the reliability and security of the grid. NERC defines reliability in two ways: adequacy and operating reliability.

*Adequacy is the ability of the electric system to always supply the combined electric power and energy requirements of the electricity consumers, considering scheduled and reasonably expected unscheduled outages of system components.*

There are six (6) primary measures contributing to Adequacy of the System:

1. Controlled to stay within acceptable limits during normal conditions.
2. Performs acceptably after credible contingencies (outages) or disturbances.
3. Limits the impact and scope of instability and cascading outages when they occur.
4. The system’s facilities are protected from damage by operating them within design capabilities.
5. Integrity can be restored promptly if it is lost.
6. The ability to always supply the aggregate electric power and energy requirements of the electricity consumers, considering scheduled and reasonably expected unscheduled outages of system components.

*Operating reliability is the ability of the electric system to withstand sudden disturbances such as electric short circuits or unanticipated loss of system components. Using its prior definition, NERC would define this as a measure of the resilience of the system.*

**ERCOT uses a variety of reliability analysis tools: overview of an alphabet mix of tools.**

Surplus dispatchable generation capacity, also known as reserve margin, is essential for system reliability<sup>33</sup> and is especially critical in an isolated or island grid. Reserve margins are set by regulatory fiat. In contrast to how it may be misused, reserve margins are supposed to be reflective of the system under stress during peak demand periods, but it is often based upon seasonal or annual average inputs and assumptions. In the Eastern and Western Interconnects,

reserve margins typically range from 12 – 18%. It stands to reason that an isolated grid should have higher reserve margins than larger geographically diverse grids. This approach is consistent with how other island grid systems approach this issue.

Reserve margins are traditionally calculated based upon the maximum available dispatchable supply (power supply available to serve the peak demand) and peak demand less demand response (demand reductions). High reserve margins reduce the probability of scarcity events (running out of power) that can lead to load shedding. High reserve margins also carry a higher cost to maintain these excess reserves. Low reserves, from a lack of resource investment would lead to more frequent load shedding events. Winter Storms Uri and Viola provided a real-world example of the overwhelming costs of load shedding and the value in avoiding similar events in the future.

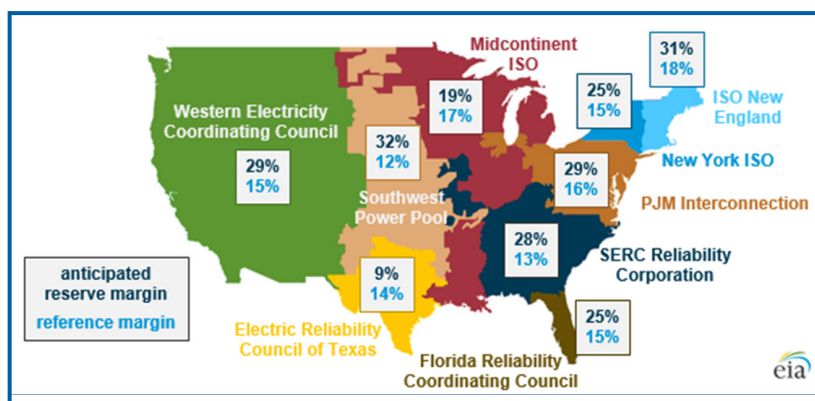

Figure 49: Summer 2019 reference margins and anticipated reserve margins in select NERC regions

Traditional models for production and reliability are based on two types of generation outages: planned and unplanned (forced outage). In general, planned outages for scheduled maintenance are purposefully scheduled to be performed during non-peak hours. Unplanned outages from equipment failures or malfunctions create forced outages that can occur at any time. Forced outages are usually unique to the specific generator unit, its age, use, maintenance levels, etc. There was not an adjustment in the ERCOT models to account for the lack of winterization even though it was well known by ERCOT since 2011. It is broadly assumed in most generation modeling that forced outages of one generator are not correlated to the forced outages of other generation units because they operate independently. This was shown to be overly optimistic when the lack of winterization of generation capacity seriously undermined reliance on this assumption. The lack of winterization demonstrated a high level of correlation in forced outage rates across all generation classes due to severe weather and was particularly acute in generation that was not winterized.

Electric systems target a reliability standard based upon Loss of Load Expectation (LOLE). LOLE is the expectation of a loss of load during a period based upon inputs from a variety of sources, including Loss of Load Probability (LOLP). LOLP is the probability or a forecast of an event/disturbance that can exceed the level of real-time reserve. In other words, an event where demand exceeds supply (generation) that in turn leads to firm load shed.

Errors in assessing this risk can be material and provide a false sense of reliability prior to an event. For example, during Uri and Viola LOLP was impacted by:

- 1) **Errors in forecasted demand.** During Uri and Viola ERCOT had forecasted a normal winter demand peak of 57,700MW and an extreme seasonal peak of 67,200MW. The estimated unserved peak during Uri and Viola was 77,819MW. Forecasting demand can be complex and is often considered a combination of an art and science, but it is highly unusual to miss a forecast by this extreme amount.
- 2) **Forced outages of Resources.** All generators have planned and unplanned outages. Planned outages are scheduled in advance and are needed for routine and major maintenance of component equipment. Forced, or unplanned outages, occur when something critical fails, forcing the generator offline until it is repaired and returned to service. There are extensive database resources to complement this input, such as NERC's Generation Availability Data System (GADS), that can provide operating histories of thousands of generating units that provide Reliability, Availability and Maintainability (RAM) information. Just like one's vehicle, reliability is driven in part by the inherent reliability of the original design, how the vehicle is operated (highway vs. city driving) and how well the vehicle is regularly maintained. The combination of these same factors will enhance or degrade forced outage rates of a specific power generator in the same way as it impacts vehicles.
- 3) **Errors in the forecast of non-dispatchable intermittent generation output.** Intermittent generation is inherently variable in its output due to the variability of its energy source (wind or solar). The electric industry, working with such groups as the NERRC, NREL and IEEE to determine different solutions for trying to measure the variable value of intermittent capacity. ERCOT has steadily increased the contribution of intermittent resources into their capacity analysis. The recent (5/6/21) ERCOT Capacity Demand and Reserves (CDR) report for 2023 indicates a summer firm peak of 78,004 MW. Dispatchable generation and non-synchronous ties of 71,961 MW and planned dispatchable resources of 1,326 MW. This would equate to a negative or (6.0%) reserve margin if only one considered dispatchable generation. However, ERCOT reports a 35.1% positive reserve margin with the inclusion of 42,310 MW of intermittent capacity.

In analyzing these three key variables that impact LOLP, there are a variety of modeling tools utilized. These methods explicitly consider the uncertainty surrounding the availability of resources, accounting for unplanned or forced outages that cannot be forecasted. The capacity value of a resource reflects its ability to contribute to improving the reliability of the system, which in turn is dependent on both time and location. Suitable convolution algorithm or Monte Carlo simulation is a probabilistic tool used to simulate the equivalent of 100's or thousands of scenarios to provide insight into an estimate of a load loss outcome. The input assumptions of the variables are critical to the quality of the analysis (garbage in/garbage out).

Instead of a “single” output, Monte Carlo simulation provides a distribution of outcomes. When properly used, it is a starting point for deeper analysis to interpret what the distribution tells the user about the assumptions and the risks to take appropriate action. Further analysis may include a variety of additional tools. Effective Load Carrying Capability (ELCC) is a tool that decomposes the contribution, that an individual generator makes to resource adequacy (usually capacity less forced outage rate (FOR)). There is a premium value for generation capacity producing during high LOLP hours – in other words electricity produced during the most important times (peak periods). It indicates if a resource helps or hurts the overall resource adequacy reliability measure. A generator contributes to resource adequacy (improves it) if it reduces LOLP in certain periods or for certain days. Loss of Load Hours (LOLH) by contrast, is concerned only with the number of hours of shortfall and does not include any dimension for persistence of an outage event. Therefore, there is no quantification about how many days the outage is spread over.

LOLE is a statistical measure, usually expressed as the number of days in a year in which available capacity is likely to be insufficient to meet demand. It is developed by calculating the daily LOLP for each day in a year and adding all these probabilities for all the days in a year. Under NERC's guidance, the industry has maintained the LOLE criterion of 0.1, the sum of probabilities for loss of load for integrated peak hour for all days of the planning year. These are considered on a seasonal (winter and summer) basis, to better reflect the different conditions leading to different LOLE outcomes (generators perform differently based upon ambient conditions). The figure of 0.1 equates to a system that would expect to experience a loss of load (load shedding event) once every 10 years. This metric does not include the duration of each event. The industry objective is to satisfy NERC standards to determine the minimum installed reserve margin required to satisfy the 1 in 10 LOLE standard. In other words, how much generation capacity, adjusted for unforeseen events, is required to adequately serve the expected peak demand and only experience one loss of load event every ten years.

NERC relies on the use of probabilistic methods and has been supporting the application of new tools to develop an input reliability from intermittent resources and allow for intermittent generation to be considered for contribution to reserve margin. There are many approaches. Wind availability can be captured in the production and reliability models by applying the forced outage rate to account for the lack of input wind just as mechanical outages are treated with conventional units. It becomes more complex to consider the variance distribution in wind output and the chronological (day, month, season, year) variation in wind output. The shortfall with this approach is that it fails to further adjust the risk of variable generation to the specifics of meeting peak day demand, no need to produce an average output variability and relies on the average from Monte Carlo simulation generating distributions of outcomes.

When a change in the LOLE is reported, the increase is typically reported as an increase of LOLE to 0.5 or 0.8 conveys, the false sense of the increase being extremely small when the actual impact is tremendous. 0.1 is a LOLE predicted event once every 10 years and a 0.5 LOLE predicts a LOLE event once every 2 years or the equivalent of a **500%** increase in frequency.

ERCOT also uses a Market Equilibrium Reserve Margin (MERM) in reporting to the PUCT. This tool is at the level so that the market can be expected to support in equilibrium, as investment in new supply resources responds to expected market conditions<sup>34</sup> This is compared to the Economically Optimal Reserve Margin (EORM). This was originally developed as an investment indicator tool. Increased intermittent resources have a disproportionate increasing impact on the shape of the net load curve caused the MERM to escalate – with the result of reducing reserve margins and increasing the frequency of reliability events<sup>35</sup>.

Another tool used by ERCOT is Operating Reserve Demand Curve (ORDC). It was introduced in 2011 to improve scarcity pricing by reflecting the marginal value of available reserves. This tool assumes that when operating reserves are low, the probability of having a scarcity event (running out supply) increases. If the scarcity event becomes severe enough, ERCOT would need to shed load, as it did during Uri and Viola. The system price should reflect the marginal value of available reserves – because reserves reduce the chance that ERCOT will shed load. ERCOT uses the Operating Reserve Demand Curve (ORDC) to create a real time adder based on LOLP and VOLL. This Value of Lost Load (VOLL) is applied to LOLP to provide economic signals concerning the value of reserve margin. VOLL is currently administratively set at \$9000/MWh (SWCAP – System Wide CAP). Based upon the discounted economics of the estimated losses incurred during Winter Storms Uri and Viola, VOLL appears to be a fraction of recently experienced costs. Using estimates of economic impacts and a range of dispute outcomes, indicates that the impact of the EEA event, assuming all hours were at the peak load of 77,819 MWh (results in reducing the unit cost) was equivalent to \$38,776/MWh to \$64,626/MWh or described another way Texas experienced real impacts



of 400% to > 700% above ERCOT estimates for the cost of lost loads. This does not include any assignment of the human costs or the costs of securitization. This does NOT provide further discounting for direct weather impacts outside of electric failures or indirect weather inputs where weather was a factor.

According to the US Department of Energy, National Energy Technology Laboratory (NETL) ERCOT summer 2020 resource adequacy report, based upon the given MERM indicates a **500%** increase in the expected level of LOLE and an **800%** increase in LOLE at the ERM value. These increases are likely at the low end of the actual anticipated LOLE since it includes ERCOT's inclusion of intermittent generation into their capacity valuation<sup>36</sup>.

“...The first change is largely a definitional change in how the reserve margin is calculated and **not a reflection** of any change in the physical system. ERCOT has adjusted the capacity credit associated with wind and solar resources known as the Effective Load Carrying Capacity (“ELCC”). For example, in 2010, wind resources were credited with 8.7% of their nameplate capacity for the purposes of calculating the reserve margin. Today, that figure stands at 14% for non-coastal wind resources. The change in ELCC increases the reserve margin, as calculated by ERCOT, by roughly 3%. The second change is a physical one and **reflects the changing composition** of ERCOT generation. During the last seven years, the growth in intermittent resources – both wind and solar – has been dramatic. Our simulation modeling indicates that the reserve margin needed to achieve a given level of physical reliability has increased substantially in recent years. For example, ERCOT's current target planning reserve margin of 13.75%, which at the time of its adoption in 2010 was intended to achieve the traditional 1-in-10 LOLE (0.1 LOLE) reliability standard, can now be expected to produce 0.63 loss-of-load-events per year, or roughly 1 event per 1.5 years. Or, looking at the shift in reliability versus reserves relationship another way, the reserve margin needed to achieve the traditional 0.1 LOLE standard has risen from 13.75% to 17.6%.”

“An increase in the ELCC, all else equal, gives the appearance of adding physical capacity to the system and increases the calculated reserve margin. However, **if no other physical changes are made to the system, physical reliability does not change**. This means that the reliability metrics that were once consistent with the 13.75% reserve margin would now be consistent with a higher reserve margin. At the current projected reserve margin for Summer 2018, ERCOT could expect 10 hours of load curtailment spread over 3.1 events. In a 1-in-20 weather year, the expected number of hours with load curtailment would rise to nearly 42. These reliability metrics generally imply load shed frequency more than thirty times that experienced in recent years, when actual reserve margins met or exceeded the level consistent with 1-in-10 LOLE. These reliability metrics, both for the baseline 9.3% scenario as well as a stress scenario 7.8% reserve margin are well below both the NERC 1-in-10 standard and the more aggressive 1-in-3 standard consistent with the ORDC design at its inception. In addition, these reserve margins produce reliability metrics that are less reliable than alternate more aggressive reliability targets that ERCOT has evaluated in the past and are that are utilized in some other regions. In particular, the 2015 Astrapé Report evaluated an LOLH standard of 2.4 hours per year, currently utilized the Southwest Power Pool, and a 0.001% Normalized Unserved Energy standard utilized by certain international markets as well. Both the base and stress case reserve margins produce reliability metrics that fail to meet these alternative standards by a considerable margin...”

Instead of a planning event for once every 10 years, ERCOT's model and assumption changes and the data indicate that it is expecting a load shedding event every 2 years or even every single year – a level 500-1000% of forecasted load shedding above the NERC industry standard.

The NETL Energy Market's Analysis team<sup>37</sup> (EMAT) study found that “...under three of the four scenarios, the region would see an increased risk for Energy Emergency Alerts (EEAs) and need to institute emergency operator actions to ensure the reliable delivery of electricity. By comparison, the composite conditions seen during the February storm exceeded even the most severe conditions simulated by NETL researchers for summer 2020. **ERCOT operates as an energy-only market, where generators are paid for producing energy but not for keeping reserve capacity on standby to meet future demand peaks**. That structure, coupled with delays in new capacity projects coming online and growing demand for electricity, created conditions for higher energy prices and the potential to declare EEAs during the summer.” The NETL study went on to conclude that “...the energy-only market structure, combined with subsidized renewables and cheap natural gas prices, drive out other forms of generation. The result of this system is often lower wholesale energy prices than other market models that pay for capacity, **but greater risks to reliable electrical service**.”

A study by Northbridge Group indicated that through its actions the PUCT and ERCOT efforts were “...leading to a 0.33 LOLE or a 1 in 3-year probability of load shed, rather than the traditional 1 in 10 standards...does illustrate a general comfort level (by PUCT and ERCOT) with this frequency of load sheds<sup>38</sup>”.

#### **The problem of over relying on models:**

Assumptions and the reliance on averages provide a false sense of reality. Systems are not stressed by average conditions. Average conditions seldom test reliability or resilience. Peak conditions usually occur during extreme conditions. In considering planning projections, it is important to distinguish that relying upon forecasted probabilistic averages provide a false sense of comfort in serving firm peak load. During the summer, there is a single late afternoon peak in contrast to the winter with two peaks. Solar production has a high correlation to serving this summer peak

need. It is appropriate to consider solar’s contribution to summer peak demand with its high correlation of output to the demand peak, while recognizing that high demand continues after the sun has set.

The winter peaks are fundamentally different. They tend to occur in the early morning before the sun rises and late in the evening after the sun has set. Severe winter storms have a high tendency to produce weather conditions with periods of limited atmospheric pressure gradient – which results in reduced wind speeds and lower wind production that are not conducive to wind production. Despite this reality, the ERCOT SARA report (5/6/2021) forecasts a winter 2021/2022 demand peak ~25% below the Uri and Viola peak and capacity reserves including these intermittent resources without considering responsible lessons learned from Uri and Viola.

There are four critical modeling issues and analysis shortcomings pertaining to reliability due to ERCOT’s approach and several secondary modeling and reliability issues:

- 1) The winterization underinvestment created a situation where one of the fundamental assumptions of forced outage diversity included in the reliability assumptions failed to account for the high level of correlation in Forced Outage Rates (FOR) across all generation capacity. The severe weather FOR correlation between dispatchable generation resources should only be eliminated when appropriate winterization investments have been made and then considered on a generator-by-generator basis. Model and assumption changes should reflect higher correlations of forced outage rates to weather driven events across all generation that is not winterized and discontinue the reliance on average input assumptions for peak system demand conditions.
- 2) Intermittent resources, based upon seasonal average assumptions are given a higher credit for capacity contribution during peak demand periods and are also likely to be discounting the regional correlation risk from similar conditions applying to all similar generation within a region simultaneously. ERCOT has been steadily increasing the contribution of wind capacity to system reserves, but a more reliability focused approach would be to reduce its contribution. The more a system relies on wind in its generation mix the less likely wind is going to be producing when the system needs it the most during peak periods<sup>39</sup>.

3) Forecasting error inputs for demand are at a level unprecedented within the industry. This type of failure indicates an over-reliance on model output with limited concern for outlying events. It also indicates a need for more extreme scenario testing and better understanding concerning the tails of the distribution analysis and how those types of events should be included in the planning process. Back testing and review of prior analysis that failed to predict actual demand and supply outcomes experienced during Uri and Viola should determine if the outcome distribution did include the potential for the event or not and the relative confidence value for that outcome. In the trading world there is a tendency to apply disproportionate weight to the experience of the prior 12 months or the last major problem in looking

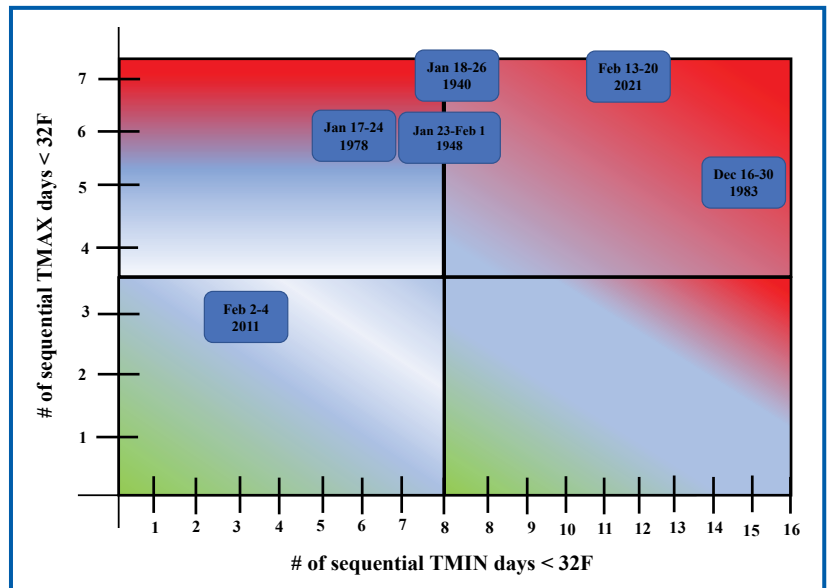

Figure 50: Major winter storms since 1940 by TMax and TMin duration severity

forward that creates a confirmational bias in decision making. The military has identified and been challenged by a similar biased self-assessment of preparing for the next event (battle or war) based upon the last one.

The bias to look backwards and primarily consider 2011 as the worst case confirms a similar bias. There was a failure to better understand historical weather events beyond the last extreme experience and rely only on the more recent event of 2011, when there were four prior storms since 1940 that indicated more severe consequences based upon the combination of T-Max and T-Min parameters.

- 4) Firm transportation capacity or firm delivered fuel supply should be accounted for in the models and adjusted based upon confirmed procurement to effectively improve the FOR outlook applicable to the unit. Lacking firm transportation and fuel supply places the generator in a position to be interrupted during winter service unless they have dual fuel capability and on-site fuel storage. An appropriate analytical approach should be employed that reflects a FOR related to extreme temperature events that applies to those generators relying upon interruptible transportation and supply. For example, interruptible transportation contracts should be modeled and reflect a temperature correlated FOR factor to account for interruption based upon temperature.

If the generator is dual fuel capable and commits to minimum storage reserves of fuel, then this should largely eliminate a fuel FOR adjustment. For the same reason, solid fuel, and biomass generation with secure access to on-site storage should be credited as having on-site fuel security.

PJM ISO performs a proactive and periodic Fuel Security Analysis across their system as a part of their resilience initiative and determining fuel impacts into their reliability assessments. This study provides a sound example of developing a common understanding of different qualities of service, dual fuel capability and how natural gas is bought, sold, and transported. In their analysis “...PJM stress-tested fuel delivery systems serving generation in the PJM region under plausible but extreme scenarios to identify when the system begins to be impacted and to identify the key study assumptions that trigger impacts to the grid. Key elements such as on-site fuel inventory, oil deliverability, availability of non-firm natural gas service, location of a pipeline disruption and pipeline configuration become increasingly important as the system comes under more stress.”

These various tools for assessing reliability are all composed of a series of assumptions that in turn drive economic analysis and statistical distributions and decisions around pricing and incentives. It is apparent how easily reliability can be lost as a touch point and how believing “in the model” can create deep biases in an organization. Relying heavily on these models without rigorous back-checking and a biased focus on reliability results in a false sense of security about reliability and resilience. There are also secondary model reliability and resilience recommendations. There are several steps that need to be taken to ensure the system assessments work more effectively and are more resilient in their response to severe conditions:

- 1) The models should reflect the costs experienced from Uri and Viola in real world (direct and indirect). VOLL and peak load margins should reflect the conditions and times consistent with such a peak demand event and not seasonal averages.
- 2) Fundamentally redesign the approach to stressing system models and invest more analytical effort investigating the extremes of the distributions, correlation of factors, and understanding real world realities to reflect in an improved understanding of risk. System reliability requirements must be reflected in other changes.
- 3) ERCOT should post daily both dispatchable-only reserve margin and the blended reserve margin (including scenarios with dispatchable resources and both with and without non-dispatchable resources) and provide a 3 year look back to better inform the public, the market and regulators of its actual situation.
- 4) Credit markets should be mandated to be staffed and fully accessible and available during severe storm events including weekends and holidays. (may be covered in EC #3)
- 5) Participants should bear the risk, through 3<sup>rd</sup> party credit support, of meeting 100% of the peak period obligations instead of ERCOT serving as an inefficient backstop. The potential risk consequences for the insurer will establish underwriting standards on the insured to make reliability investments and take appropriate risk management and control steps. If effectively implemented this would have eliminated the need for the securitization. (may be covered in part by item #3 of EC workgroups)

**Further Analysis**

**Natural gas industry failures**

During the data gathering process ASCE Texas Section confirmed, consistent with other analysis, that there were physical infrastructure issues, such as weatherization underinvestment in both the electric (generation) and the natural gas industry (production area) infrastructure. The natural gas industry was initially blamed for failing to weatherize their infrastructure to supply electric power generators, which in turn was responsible for the gas fired generators to trip offline. ASCE Texas Section determined that a deeper assessment was warranted.

**Natural gas fuel supply failure:** Natural gas production is not concentrated in a few producers but supplied by a diverse set of them. The largest single producer in Texas accounts for only 8.464% of production, the 2<sup>nd</sup> largest accounts for 4.716%. The top 5 producers account for 23.864% of Texas production and the top 32 natural gas producers account for 69.180% of production . In evaluating fuel supply issues, one must understand the nature and quality of the supply and transportation services contracted for by the generator. If interruptible supply or transportation was procured, it should come as no surprise that source of supply was interruptible during a peak demand period. It should be noted that parties involved have been reluctant to share specific information related to contracting and supply contracts, except through informal off-the-record discussions due to potential litigation and regulatory concerns.

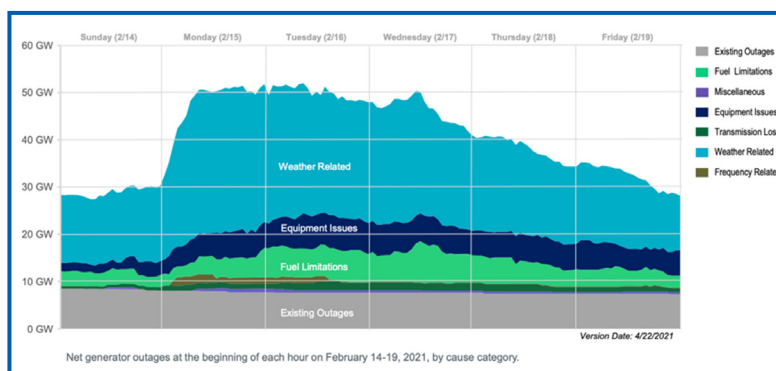

Figure 51: ERCOT Net Generator Outages and Derates by Cause (MW) – February 14-19, 2021

A more detailed assessment, including discussions with industry participants and reconciling differences between the electric day (00:00 to 23:59) and the natural gas market day (09:00-08:59), arrives at a different conclusion. Prior to the storm, Permian production was averaging approximately 11.7 BCF/day. Approximately 20% of total physical production lost during the storm from the Permian production basin peaked at a cumulative ~2.3 BCF/day prior to beginning of load shedding.

These production declines are largely attributable to weather and weatherization underinvestment by the natural gas industry. These production declines were first observed on Thursday (2/11/21) and gradually increased each day as the storm intensified leading up to early Monday morning (2/15) when major load shedding began. Prior to the load shedding event, natural gas fuel issues were negligible in attribution to forced outage impact to natural gas generation.

It appears that a majority of the natural gas curtailments were driven by fuel supply disruptions that were **commercial** and not operational in nature, such as inadequate firm supply, firm market area storage and firm transportation commitments by generators to serve their peak winter loads. As FERC-NERC analysis confirmed, ~75% of electric generators that experienced fuel related problems relied on interruptible fuel supply and/or transportation. It should come as no surprise that they were in fact interrupted during peak demand periods.

After curtailment of electric supply to field level operations, major declines in production were experienced and continued through Tuesday (2/16) with a cumulative ~6.4 BCF/day of incremental production lost after electric curtailments were initiated. This amount equates to ~55% of pre-storm production levels and approximately 75% of the total Permian production decline.

In total, Permian production was reduced from 11.7 BCF/day to ~3.0 BCF/day, a total reduction of 8.7 BCF/day during Winter Storms Uri and Viola. In simple terms ~25% of lost Permian production occurred prior to electricity curtailments and ~75% of the lost production coincides after electricity curtailments which is also coincident with subsequent cascading impacts of fuel supply issues contributing to forced outages. In essence, the electric market unknowingly curtailed its own fuel supply due in part because the natural gas industry failed to properly identify critical resources with the electric utility industry. The minimal natural gas industry upstream winterization investment and electric dependent winterization with limited back-up made the situation worse.

This analysis does not absolve the natural gas industry from scrutiny concerning their failure to adequately harden their infrastructure for winter storms, from production to midstream, and to take proactive steps to mitigate infrastructure interdependence risk. Decisions by producers, such as full field electrification without adequate contingency investments in back-up generation or microgrids to ensure reliability increased interdependence risk and the risk of cascading failures across infrastructure sectors that contributed to fuel disruptions to natural gas generators.

It is ASCE Texas Section’s perspective that a reliable natural gas system is critical to serving all its customers, from residential and LNG customers to the electric generation market. Reliable natural gas infrastructure, with weather hardened infrastructure and mitigated interdependence risks are an essential cost of doing business.

Wood Mackenzie estimates that the cost to winterize an estimated 30,000 existing wells that were not fully winterized is ~ \$1.5 billion. The Texas Railroad Commission should facilitate changes that support both resolving legacy underinvestment as well as require minimum weatherization standards going forward for incremental production. There is an ASCE Texas Section, Beyond Storms Task Force sector sub-committee focused on the changes that are required for this sector.

44

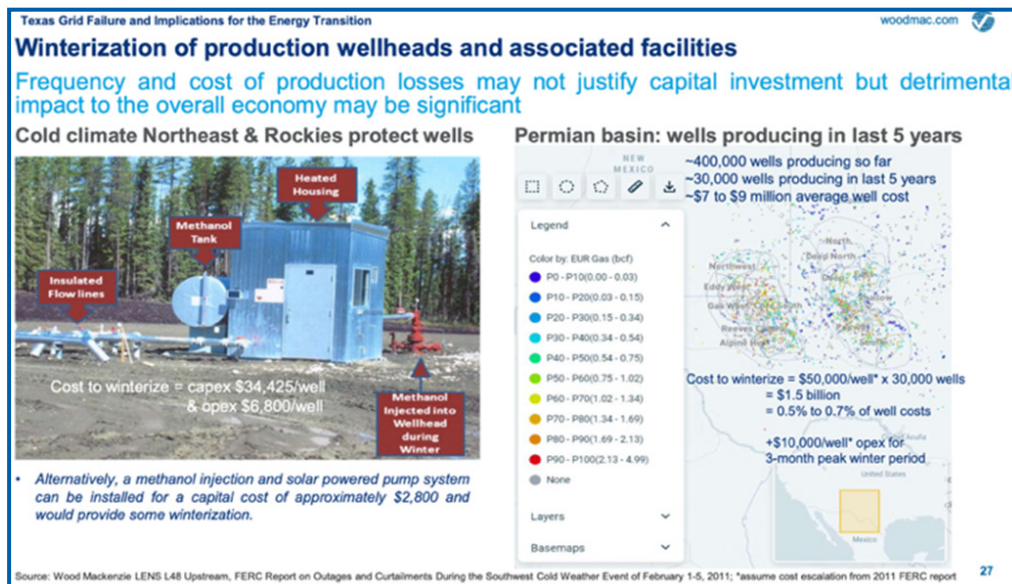

Figure 52: Texas Grid Failure and Implications for the Energy Transition – Winterization of production wellheads and associated facilities

New services including incremental market area, natural gas storage is also needed to serve the increasing cycling nature of gas fired generation. The natural gas industry should expect the electric generation industry to pay their fair share of the costs of these services. The natural gas industry should not put its proven capacity market model at risk in serving the energy only electricity model of ERCOT to the detriment of existing customers.

**Why was there chronic underinvestment?**

Knowing and understanding “what happened” is only the first step in understanding “why it happened.” In analyzing the reasons for the underinvestment, the evidence kept pointing to flawed regulations and weak practices and processes that led to the chronic underinvestment. There are two primary contributing factors:

- 1) **ERCOT market design fails to support reliable generation.** The energy only market structure fails to recognize the reliability value of both black start emergency generation and dispatchable generation and the negative impacts of subsidized generation. Because ERCOT is an energy only market, the only way that a generator can pay for its investment is from the revenue from the electrons it generates and the related services it provides.

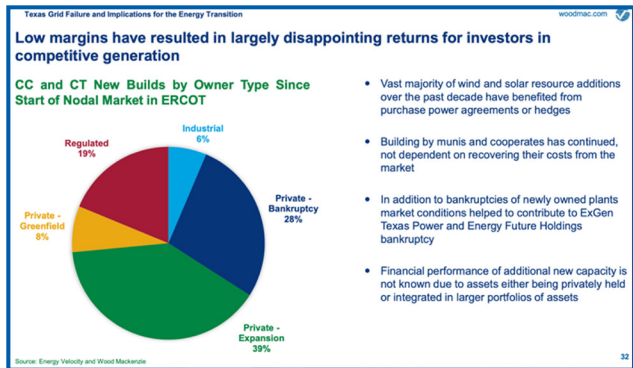

Figure 53: Texas Grid Failure and Implications for the Energy Transition – Low margins have resulted in largely disappointing returns for investors in competitive generation

According to Wood McKenzie, in all years since 2011, except for 2019, the ERCOT energy revenues have been insufficient for a new generator to earn an adequate return on capital. The economic reality for critical black start generators, ERCOT’s last line of defense<sup>42</sup> when everything else fails, mirrored the same issues. These critical fail-safe resources should each have a minimum of 14 days of 24/7 on-site fuel supply and dual fuel capability.

Why is this so critical?

**Black start generation.**

The concept of restarting the grid appears simple, but the reality is far more complex. Many safety and control systems will have been compromised in the shutdown. Each of these must be inspected and isolated. Generators have a great deal of rotating equipment, pumps, safety, and control systems that must orderly started up when returning the generator to service. In normal operations, the plant relies on power supplied by the grid to start-up this equipment. Under black start conditions this is not an option. Large power plants must rely on black start generators for this energy source. Individual parts of the grid must be isolated to allow critical black start generators to assist in the start-up of major generators. These black start generators are the ultimate backstop to the system and must be well maintained, highly reliable and able to operate under a wide range of conditions supplied by dependable fuel. With the grid completely out of service, one must assume widespread impacts to the natural gas system, compromising natural gas fuel supply. The critical importance of dual fuel capability for black start generators with sufficient fuel stored on site is obvious. If black start generators fail to start or have compromised fuel supply, they cannot support the restarting of the grid. Once the generators are back on-line end users on the system can be slowly brought back on-line, constrained by a lack of load diversity, creating higher than normal network loadings. There will be other complications that further complicate the return and restoration of the grid. With expected cascading damage following such a catastrophic event, the system could potentially take weeks or months to fully restore. As noted previously (see background section of Detailed Recommendation #1), the fail-safe back-up generation to prevent and mitigate such an event was not reliable.

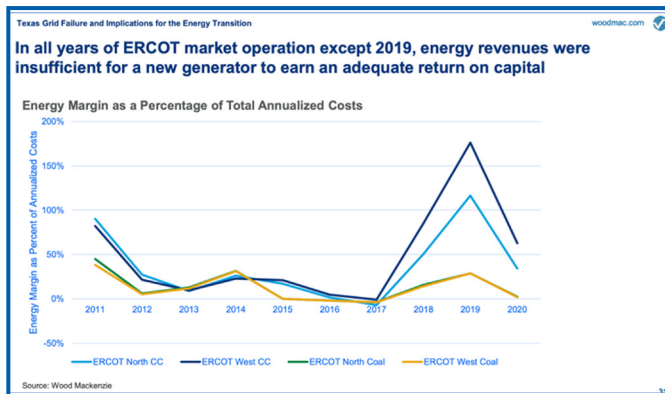

Figure 54: Texas Grid Failure and Implications for the Energy Transition – In all years of ERCOT market operation except 2019, energy revenues were insufficient

- 2) **Negative impact of intermittent generation.** There is a tremendous reliability and resilience difference between intermittent and dispatchable generation. The market structure needs to reflect this difference and include a recognition of the federal subsidies that warp the market outcomes. The choice of technology should be agnostic and not favor one resource over another, but rather ensure a level playing field where reliability is a core factor in the market and in how reliable generation is compensated.

An increasing presence of subsidized intermittent generation has driven down energy market pricing and lowered energy prices to dispatchable generation. It is estimated that non-dispatchable generation has received billions in Federal credits since 2006, not including state level transmission upgrades that are not accounted for in wholesale energy prices .

“...IHS Market asserts that subsidizing the cost of renewable generation is distorting the market, causing the share of wind generation to exceed its cost-effective level. The study argues that wind output is disproportional to the ERCOT demand curve, which means wind generates more power while demand and market clearing prices are lower. **With subsidies, it distorts the wholesale energy prices and even causes negative prices in ERCOT.** On the other hand, major transmission projects have been built to transmit renewable-generated power, and the cost of those projects is **not accounted for in wholesale energy prices...**”

The negative impact on the ERCOT demand curve which distorts wholesale energy prices and even causes negative prices. This reduces revenue streams to dispatchable generation and has led to revenue insufficiency. The energy transition driving increased cycling conditions on dispatchable generation creating increased costs at the same time revenues are being reduced.

Increased cycling of dispatchable generation to serve system needs unmet by intermittent resources, increases its O&M costs (including longer duration of outages and increased frequency) and negatively impacts reliability through increased effective forced outage factors (EFOF) and availability through longer planned outages. There are reliability impacts from how the units are dispatched. The impacts from flexible operating regimes include thermal fatigue, thermal mechanical failure, differential thermal expansion, corrosion, and environmental control equipment performance as leading issues. For example, every cold start of a turbine has O&M impacts equivalent to 3 warm starts and 5 hot starts due to thermal stress and shortens the time span between more costly major maintenance cycles and increases the frequency of routine planned outages. Changing operational requirements increases the complexity of the services and infrastructure required to serve these loads. Increased cycling also presents more complex decisions concerning firm transportation and firm gas supply. As the utilization of the unit declines, the time periods to recover costs are reduced and fixed costs become an increasing burden and risk.

These challenges can be solved, but they require incremental capital investments to ensure reliable technical and market solutions. Expanding market-based solutions to adequately serve this changing demand, such as no-notice gas supply service, will likely require incremental infrastructure of reliability supporting investments such as market area gas storage with high deliverability characteristics of salt dome storage. These investments will need to be supported by market commitments

Winter Storms Uri and Viola appears to be a 1 in 100- or 130+-year risk event. In an energy only market, it is not rational to expect a generator to make the capex investment needed to winterize in the hope of earning back the investment in an energy only market when the market price signals do not support the investment. Changing the rules to penalize generators if they fail to make this optional investment undermines confidence in the market and creates regulatory uncertainty. It also fails to resolve the original problem – the energy only market was not offering sufficient certainty to a generator to make the investment and was essentially communicating that reliability was not needed. Until it was needed.

***The central problem is that the asymmetric risk of the severe consequences for failing to have the required capacity is not properly captured in the legacy energy only market structure.***

Any kind of critical infrastructure that is not economically supported on a consistent basis to make and maintain the routine capital investments needed for reliability will not perform reliably. It will run until it breaks. The legacy energy-only model is a “run to failure” model.

In most instances, there is a 2 – 5+ times net higher cost for this reactive maintenance approach instead of a reliability centered approach of adequate funding through the Best in Class alternative of Reliability Centered Maintenance (RCM<sup>44</sup>). This 2-5 times benefit does not even consider the impact of the asymmetric downside risk. It would be appropriate for the energy-only model to be adjusted to reflect the reality of the consequences for failure and approach reliability prudently with a reliability centered strategy.

The preliminary ASCE Texas Section validation effort led to a series of further questions. If dispatchable generators were not investing in winterization, were they likely to be investing to improve individual plant reliability and operational flexibility? Were they acquiring firm take or pay transportation capacity to ensure

year-round reliable performance of their fuel supply? Were they acquiring firm fuel supply and complementary storage services to enhance the reliability of its fuel supply? or investing to have and maintain dual fuel capability? Would new entrants be attracted to this risk/reward imbalance to build incremental new-build dispatchable generation investment in ERCOT? One might look to the answer reflected in unacceptably low reserve margins. The simple answer was probably not.

Even if the extreme weather event is 1 in 10 years, the supporting rationale for the incremental investment is extremely low. In 2011 there was a winter event that confirmed the need for winterization. However, until February 2021 there was not actual market demand for winterization that would have potentially allowed recovery of the investment. When reliability is important to a market, capacity is valued and compensated in the market for standing by and being ready to serve. The market can then establish standards and performance requirements, including winterization and higher reliability investments that generators are required to satisfy to earn capacity payments. The reliability payments should be sufficient to ensure revenue sufficiency to support these reliability investments.

**What does it cost to address these identified issues?**

This is a very complex issue that would require resources far beyond those as mentioned in this report to analyze the required investments on a generator-by-generator basis. Reliability may cost more money in the short run and isolated island systems require higher reliability levels. However, not having reliability costs far more in the long run. There are several different approaches proposed by 3rd parties after the storm:

**Extreme high case**

In an extreme example, an entirely new fleet of gas fired generation sufficient to provider for > 100% reserve margin of ~85 GW at \$1100/kW could be built for < \$94 Billion - a fraction of the economic costs incurred by Uri and Viola. This type of reliability investment would be wasteful.

**High case**

On March 25, 2021, Berkshire Hathaway Energy offered to invest \$8 billion to build 10 new natural gas fired power plants (10,000 MW of capacity). Lawmakers would have to agree to create a revenue stream to provide Berkshire a return on its investment through an additional charge on its power bills.

Both high cases assume the need for incremental gas fired generation. The system may require incremental dispatchable generation, but ASCE Texas Section believes that ERCOT should prioritize its focus first on supporting the existing fleet of generation to become more reliable at a fraction of the cost of incremental new generation. The ASCE Texas Section assessment is that the more costs effective approach is that system needs to provide the existing gas fired generation sufficient revenue to support them becoming more reliable and that incremental cost is substantially less than either of the high case options. Once that action is completed then it is appropriate to determine

if incremental dispatchable generation is needed. Developing detailed estimates for dual fuel conversions, fuel storage infrastructure, generator reliability upgrades, firm transportation for those generators without firm transportation require a detailed assessment on a unit-by-unit basis which is beyond the scope of this project.

There are some costs that are reasonably well known, such as the estimated cost to winterize generation. Wood Mackenzie’s cost estimate for winterizing a CCGT on a retrofit basis is \$10 - \$60/kW for existing CCGT generation.

Using this range of values means that a typical 500MW CCGT plant would require

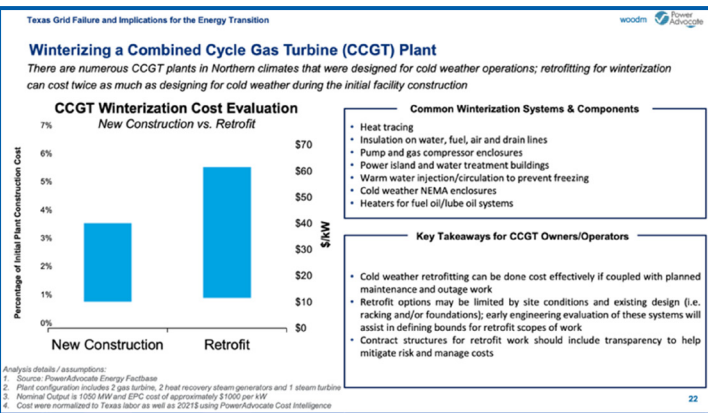

Figure 55: Texas Grid Failure and Implications for the Energy Transition – Winterizing a Combined Cycle Gas Turbine (CCGT) Plant

\$10 - \$60 x 500MW x 1000kW/MW = \$5 to \$30 million of investment to fully winterize a 500MW generator. There is 53,000 MW of gas fired capacity in ERCOT. If 100% of this capacity requires winterization that would equal an estimated \$530 million to \$3.2 billion of potential investment.

Evidence indicates that arctic weather fronts (coincident with the highest winter loads) usually also correspond to periods of limited atmospheric pressure gradient – which results in reduced wind speeds and lower wind production. Similarly, the timing of the double winter peak periods occurs during the early morning and late evening, preventing solar from making a meaningful contribution to serve critical loads during these peaks. Investing capital in an intermittent low utilization resource to winterize its availability, even if the upgrade technology is available which is uncertain, under these circumstances makes limited economic sense.

### Understanding the remaining reliability costs

There are several different reliability investments that existing generation require to perform reliably and potential incremental investments that can further improve reliability. For example, capital improvements that extend the turndown capability of a turbine, so it can operate reliably at lower output levels, can improve its flexibility, reliability, and resilience.

This would normally require a detailed generator-by-generator assessment which is beyond the scope of this project. However, in a simplified approach<sup>45</sup> one analysis considered comparing at a high level against an existing capacity-based power market for an indicative answer. PJM in an RTO that originally included Pennsylvania, New Jersey, and Maryland. It was expanded over time to now includes all or parts of Delaware, Illinois, Indiana, Kentucky, Maryland, Michigan, New Jersey, North Carolina, Ohio, Pennsylvania, Tennessee, Virginia, West Virginia, and the District of Columbia. PJM is a capacity market Regional Transmission Organization (RTO) that they term a Reliability Pricing Model (RPM) operating in 13 states and DC in the eastern interconnect. As described in the PJM learning center website:

“...PJM’s capacity market, called the Reliability Pricing Model, ensures long-term grid reliability by procuring the appropriate amount of power supply resources needed to meet predicted energy demand three years in the future. Under the “pay-for-performance” model, resources must deliver on demand during system emergencies or owe a significant payment for non-performance. Think of this like an insurance policy – for a small additional cost (payment to resources which perform well), consumers will have greater protection from power interruptions and price spikes during weather extremes. By matching power supply with future demand, PJM’s capacity market creates long-term price signals to attract needed investments to ensure adequate power supplies.”

“...Capacity represents a commitment of resources to deliver when needed, particularly in case of a grid emergency. For example, a shopping mall builds enough parking spaces to be filled at its busiest time – Black Friday. The spaces are there when needed, but they may not be used all year round. Capacity, as it relates to electricity, means there are adequate resources on the grid to ensure that the demand for electricity can be met at all times....” Electricity reliability is certainly more critical than parking lot space at the mall to serve its peak demand.

This analysis considered the average capacity cost over a 10-year period from 2011 to 2021 in PJM and adjusted this to the equivalent size of the ERCOT market. Over this ten-year period the amount would have translated to a total cost of \$14 billion. This equates to ~\$1.4 billion per year. This amount is < 5% increase in prices in a \$37B annual energy market. The value of reliability is overwhelming, and the estimated investments needed for improved reliability that are likely to be lower when implemented. While this comparison is only indicative in nature, there is value from this comparison. The incremental costs in PJM philosophically include many of the investments that ASCE Texas Section has recommended for ERCOT. These investments include revenue sufficiency for dispatchable generation, dual fuel capability with on-site storage and reliability associated compensation to support seasonal reliability and performance upgrades coupled with winter availability standards supported by firm fuel supply.

#### The challenge of interdependence:

ASCE Texas Section identified patterns that indicated interdependency issues between infrastructure sectors that were contributing to substantial increases to the instability of the system. There are two types of interdependence.

The **explicit interdependence** of the systems was generally well known and understood. These are planned and well-known interdependence areas, such as telecom and water & wastewater treatment system reliance on electric service. In each situation there is usually thoughtful consideration about the operational impacts from the reliance on the interdependence, need for back-up generation, etc. For example, the water and wastewater industry took steps to ensure back-up generation on their key infrastructure was in place and operating which decreased and mitigated the potential impact of explicit interdependence and enhanced reliability. Some systems still lost their operational awareness and control over some or all their system due to un-mitigated interdependence.

The second type of interdependence is what ASCE Texas Section refers to as **interdependency creep**. This occurs where individual decisions about integrating with another sector might not rise to a level of awareness or concern but when this one-off integration is repeated hundreds or thousands of times the result creates a systemic issue. This problem is like scope creep on a project where seemingly minor changes create serious impacts to project costs and schedule. For example, there are literally thousands of individual decisions that have led to increasing dependence of the natural gas industry on the electric industry from systems and controls, to heat supply and conversion to electric compression. Collectively these decisions have reduced the reliability and resilience of the system and made it more fragile. While interdependence of the electric industry on the natural gas industry has been identified as a problem for a few years, mutual interdependence was largely overlooked.

Interdependence will only increase over time. However, there are steps that can be taken to mitigate interdependence. Critical infrastructure owners should invest in creating reliability islands or microgrids with back-up generation with extended on-site fuel supply to complement and enhance the reliability of both their infrastructure and the ERCOT grid. Any solutions that interface with the grid must include robust and well-maintained cyber security and LDCs should be permitted to compete to develop, own and operate these systems outside of and unsupported by their rate base.



Individual infrastructure sectors, like water/wastewater/stormwater, natural gas, and electric distribution networks should implement back-up monitoring solutions to their internal operational and control systems to ensure that operators maintain operational control and insight and improve resilience through accelerated failure identification and prioritization for faster recovery post severe weather event.

Natural gas production in the Permian was routinely constrained due to the tremendous growth in production levels combined with a lack of available export transportation capacity out of this basin, resulting in depressed and even negative prices for natural gas supply. This was not an environment that typically supports incremental investments in winterization. This is not meant to be an excuse for under-investment, but rather to provide context. The RRC and Producers need to develop an appropriate minimum field level winterization requirement for production wells to mitigate freeze-offs to support the increasing level of firm winter demand from residential, generators, LNG markets, industrial markets and incorporate gathering midstream and processing hardening as well.

**Other Market based solutions:**

New approaches to contractual firm delivered fuel supply and transportation for dispatchable generators, complemented by incremental market area storage. Incentives to install and maintain dual fuel capability in some minimum portion of the natural gas generation sector. Contractual arrangements that allow for the appropriate compensation of LNG plants to redirect natural gas for short term peak system needs should be encouraged to increase systemic reliability.

We also confirmed physical infrastructure failures driven by non-physical issues. The infrastructure failed because of how it was being used or because of failed processes, market design, training, and culture. Examples of this include:

- Lack of cross-sector disaster simulation exercises (stressed seasonally) and an institutional culture to routinely drill and train like other reliability critical industries. At the minimum, these efforts should include representatives from each sector that has critical interfaces during extreme events including representatives of the electricity market, credit providers, the natural gas transportation industry, natural gas suppliers, storage owners, water and wastewater operators, telecommunications, transportation, and governmental agencies. On a long-term basis, a mixed market simulator should be developed to allow simulation and response under various scenarios to be practiced and learned from.
- The Critical Load Filing process is largely a paper-based process, does not require LDC upgrades in how they manage their system during extreme events and design and installation of the incremental investments required (SCADA, controls, relays, etc.) to properly support the administration during an event and a consistent misimpression that over-weighted the relative value and quality of this service misperception.

**Policies that enhance or undermine reliability:**

As stewards for critical infrastructure, we understand that 100% reliability of our energy infrastructure may be aspirational, but it is also uneconomical. It is our responsibility to recommend changes that prioritize where the time, effort and money is invested on the most impactful areas. It is also our responsibility to consider solutions that can be deployed in the near term and improve reliability needed today on this project.

There are many policies that inadvertently decrease reliability on the system. We believe that reliability should be a foundational issue in regulatory policies and rules. We have developed the table (#4) to provide examples of bad, better, best range of outcomes with respect to reliability for a wide range of policies.

**The challenge ERCOT and the PUCT - Institutional bias**

There are two separate efforts underway to address the winter storm. The first is the ERCOT roadmap. ERCOT’s road map<sup>46</sup> to improving grid reliability lists 60 action items to focus upon following the Winter Storm and is really a formal confirmation of implementing the requirements needed to satisfy Texas SB2 and Texas SB3. We attempted to broadly categorize the 60 actions into major subject matter areas:

Direct Storm Analysis	Model Updates	Updated or New Reports	Updated or New Rules & Changes	Update or New Procedures	Operations	Audit or Inspect	Communication	Future Analysis	HR & Personnel	Market Structure
2	10	3.5	6.5	3	5	3	16	9	3	0

Table 4: Categorization of Actions Into Major Subject Matter Areas

Black start is not mentioned until after the half-way point at #37 on ERCOT’s priority list. The single largest category of projects for ERCOT’s action plan were 16 items related to improving communication issues and only one related to black start generation (#37). This is not to discount the importance of communication, especially in an emergency event. However, it highlights the relative importance assigned to a mission critical issue or reliability and resilience. There is nothing new in this road map which is essentially adopting the required outputs from Texas SB2 and SB3.

The second set of efforts is more meaningful. It is being pursued through a series of working groups. There are 128 different items on the Emergency Conditions List (TAC 082721). These various teams address a wider set of issues, and they are generally deep in detail. Several of the efforts are waiting for direction from newly formed organizations under SB3. These various groups are working in parallel and periodically are put on hold for gating items. The following items from the Emergency Conditions List have overlap or potential overlap with some or all our proposed recommendations<sup>47</sup>.

There is some overlap with ASCE Texas Section's efforts. However, it is premature to understand the substantive conclusions and recommendations at this point in time. Even in the working groups, there is some evidence of behaviors consistent with a troubling institutional bias to want to look good vs. be good.

Group think paralyzed recognition of fundamental failures and was reinforced by the belief in the model that was found to be materially incorrect. Reserve margins for ERCOT have been biased lower than most comparable systems that operate interconnected systems versus an island system which should naturally have higher reserve margin standards. The energy-only market design concealed flaws induced by regulatory and political externalities and technology advancements, which, as expected, were exposed through extreme circumstances<sup>48</sup>. We observed patterns of modeling bias and “**reliance on the model**” in the face of reality painting a very different story.

For example, the winter demand peak experienced during Winter Storms Uri and Viola significantly exceeded forecast demand and was not forecasted to be hit until 2032. The same model bias indicated that incremental generation would be made available at prices of \$9,000/MWh. The same models forecasted optimistic generation availability despite knowing that winterization investments had not been made. The solution appears to consistently return to the same models and adjust them, instead of re-examining the fundamentals of why the material difference occurred in the first place and that there might be flaws in the market model.

A failure to routinely practice and simulate disasters with the appropriate parties and with the appropriate seasonal conditions and scenarios is a systemic problem. Best in class network owners regularly plan and routinely practice for disaster conditions and they make sure to include adjacent participants that are an essential part of the potential real-world event. At minimum, these efforts should include representatives from each sector that has critical interfaces during extreme events including representatives of the electricity market, credit providers, the natural gas transportation industry, natural gas suppliers, storage owners, water and wastewater operators, telecommunications, transportation, and governmental agencies. On a longer-term basis, a mixed market simulator system should be developed to allow simulation and response under various disaster scenarios to be practiced and learned from.

The winter storm of 2011 provided a platform to identify many of these problems, but it appears that there was a tendency to attribute many of the issues to the specific storm and not to potential flaws on the energy only market model. ERCOT management claims they did not have “authority” to require winterization investments, yet during the prior decade leadership had ample time to build the case for needed changes and authorizations and failed to pursue them.

Based upon presentations and our analysis ASCE Texas Section concluded that reliability had become a frequently used buzzword without actionable meaning. Reliability cannot be “inspected” into the system. **Reliability must be integrated into daily operations like safety.** A report does not fix reliability issues. It takes actions. A series of smaller reliability issues consistently lead to larger reliability issues, like minor injuries lead to loss time injuries. Reliability can only be achieved when it is integrated into a fundamental way of doing business, day in and day out. Reliability considerations must be woven into our daily decisions and drive our actions. Reliability demands, we speak candidly about the problems and contributing factors so that we can understand them and fix them. Regardless of the driving factor, we must as an industry and as Texans, be able to candidly discuss problems with a focus on reliability and resilience.

Collectively, these observations and conclusions indicate a pattern of behavior that needs to change and a culture that needs to be focused and prioritized around reliability and resilience.

#### **Regulatory and political response**

The recent Texas SB2 and Texas SB3 were passed to address the issues as they were understood in the aftermath of the extended black-out. SB 2 focuses on changes to ERCOT governance with 8 ERCOT board members appointed by a political selected committee of 3 members (governor, Lt governor and speaker), replacing members from various market sectors appointed by the members of ERCOT<sup>49</sup>. This board should include industry experts and should be focused on the best most capable personnel to fill these roles independent of their state of residence.

Texas SB3 is a much more complex bill. It establishes 4 new regulatory and advisory committees with various levels of authority and responsibility. It creates many new obligations on market participants including significant capital investments and potential heavy penalties, but little direction or indication of funding. It also establishes a performance target to prevent “**prolonged rotating outages**” This is an unacceptably low threshold when the consequences of rolling outages are severe in their impact to public and economic health. The bill appears to complicate matters by

placing further financial obligations on other sectors for the inherent failures and revenue insufficiency created by the energy-only market design. If the electric market had a capacity structure, where dispatchable generation had the resources and requirement to underwrite these reliability investments then it is highly probable that the infrastructure required would be built-out and market driven solutions would compete to provide the service. There are several areas of material concern with respect to the language or organizations:

### Systemic concerns

- The legislation is silent on several key issues and does not go far enough in addressing the fundamental shortcomings of the energy only market structure, including a less than urgent failure to address the shortcomings and failures of black start generation.
- The legislation appears to push the energy only model structure for electricity onto the capacity based natural gas industry model to the detriment of reduced reliability to both systems.
- Many of the fundamental flaws uncovered by Uri and Viola come down to an understanding of how the energy only model fails to compensate reliable capacity as a major contributing factor coupled with the negative impact of subsidized intermittent generation. The proposed solutions are long on penalties, for something neither paid for or required by the market and short on determining who and how it is paid for.
- Failure of the proposed fixes to the critical load filings to materially improve reliability.

### Reliability damaging language

- Establishing a “**prolonged rotating outage**” standard for dispatchable generation is detrimental and potentially dangerous to system reliability and establishes the acceptability of a lower performance threshold to reliability. Words are important. Prolonged means: continuing for a notably long time, extended in duration, protracted, drawn out.
- Scheduling load shedding exercises during the peak season is detrimental to reliability and should be scheduled and completed prior to the beginning of each peak season. Routine training should be ongoing.
- Critical natural gas facilities and entities during an energy emergency failed to address the outcome if the event of curtailment is driven by a physical system failure (ice storms). It does not address mitigation alternatives or encouragement to mitigate and simply results in an increase of firm load to the system which decreases reliability. It also reduces system flexibility by increasing the firm system loads.
- Excusing reliability if serious financial burden. It needs to be funded another way, not excused.

### Creation of critical bodies lacking accountability or industry participation

A reliable system is driven by an absolute clarity of roles and responsibilities and appropriate checks and balances in the system. The sheriff cannot also be the one to write the applicable laws. The rules need to be focused on the root cause and must look beyond just the storm issues. No sector or market participant should get a pass on reliability.

- Texas electric supply chain: Fails to recognize quality of service acquired or include industry participation or validation.
- Texas Energy Disaster Reliability Council: Lack of transparency for any governmental agency is unacceptable and it lacks industry participation.
- State Energy Plan Advisory Committee - Needs industry participation by experts.



## CONCLUSION

**The problems uncovered by Winter Storms Uri and Viola can be solved.** They are very challenging, and they are not solved overnight. They are also not solved by simply throwing money at them. The failure to recognize the scale and scope of the problems and the effort required to invest in the appropriate actions needed to fix them is deeply concerning.

Some problems are very specific and unique to Texas on a micro basis. Other problems are systemic, like the chronic failure to ensure revenue sufficiency to adequately fund the operation, maintenance, and repair of critical infrastructure and this undermines reliability and resilience for all sectors of critical infrastructure. These problems, driven by unintended consequences of policies and regulations can arise from market structures and non-market situations. Systemic problems usually require systemic solutions. We need to establish revenue sufficiency requirements to adequately operate and maintain critical infrastructure in an economically sustainable manner. This will help ensure we begin addressing a core systemic problem and change course from the “run to failure” tactic to the strategic economically sustainable approach. We can no longer fail to consider this issue if we want to build and maintain a reliable and resilient infrastructure serving the public. A new coat of varnish on the boat may make it look better, but if you haven’t fixed the hole in the bottom, it will predictably sink next time it is used.

This moment demands that we fundamentally change our thinking, priorities and our approach concerning reliability and resilience. Absent change, this situation will only get worse. This is not just a Texas issue. It is an industry-wide issue. This reality is like the fallout from the failures of equipment, individuals and processes that was last experienced on this scale in the US energy sector from the Three Mile Island event.

There is a choice for Texas. If Texas continues this current path, Texas will experience increased frequency of these catastrophes and these events will be triggered by more mild weather events than we experienced last February 2021. Alternatively, Texas can rise to the challenge and lead the way in a reliability centric energy transition. Texas can be the catalyst for change in creating a more reliable and resilient electric system to cost effectively meet the growing needs of Texans.



## End Notes

1. The Perryman Group (2021), Preliminary Estimate of Economic Costs of the February 2021 Texas Winter Storm, February 2021. (low case = \$197.2B, High case= \$295.8B)
2. The Perryman Group (2017), Preliminary Estimate of Economic Costs of Hurricane Harvey, August 31, 2017 (\$145B). and NOAA.gov Office of Coastal Management, Fast Facts - Hurricane Costs
3. US Department of Energy, Energy Information Administration: <https://www.eia.gov/electricity/state/>
4. T Popik and R Humphrys (2021). The 2021 Texas Blackouts: Causes, Consequences, and Cures. Paper and presentation The Journal of Critical Infrastructure Policy, spring/summer 2021
5. Mose Buchele, Matt Largey (2021) If the Texas Power Grid Had Gone down, it would need a black start! How Long would that take?" KUT Radio, Austin's NPR station, August 5, 2021
6. The various parallel efforts include:
  - EC item #34 – review availability and task adder on dual fuel and onsite storage,
  - EC Item #5 & #3 - outage scheduling,
  - EC Item #77 - reliability requirement
7. United States Department of Energy (US-DOE), National Renewable Energy Laboratory (NREL), (2016) NREL Revenue Sufficiency and Reliability in a Zero Marginal Cost future
8. United States Department of Energy (USDOE), National Renewable Energy Laboratory (NREL), (2016) NREL Revenue Sufficiency and Reliability in a Zero Marginal Cost future, 2016, page 7
9. Wood McKenzie (Woodmac.com) 2021) Texas Grid Failure and Implications for the energy transition March 4, 2021)
10. Wood Mackenzie (2021), Texas Grid Failure and Implications for the Energy Transition. March 4, 2021
11. Liz Hamilton 2021, Yahoo Finance, 8/11/2021, Gas Producer BKV Corp to buy Texas Power Plant for \$430 Mln. The indicative price for a new CCGT is approximately \$1100/kW. \$430MM for a 758MW CCGT plant is ~\$567/kW.
12. Related to parallel efforts include:
  - EC item #39 and #80 - Root cause analysis, review of resource adequacy
  - EC item #72 (firm fuel), #64 market area storage #95 cost benefits of dual fuel storage
  - EC item #82 – intermittency
  - EC item #38 – winter weatherization #65 – winter summer weatherization
  - EC #77 – reliability requirement
13. These parallel efforts include:
  - EC item #56 – situational awareness
  - EC item #72 – firm fuel, #64 market area storage, #95 cost benefits of dual fuel storage
  - EC item #39 – overall root cause analysis, #80 resource adequacy
  - EC item #63 – process of identifying critical infrastructure
14. EC item #34 – black start reviews of availability, adder of dual fuel and on-site storage
  - EC item #39 – root cause analysis
  - EC item #80 – resource adequacy
  - EC item #56 – situational awareness
  - EC item #3 – comprehensive review of settlement and credit worthiness; #107 – changes needed based upon event and #115 – QSE related credit issues
  - EC item # 47 - weather forecasting
  - EC item #55: Demand response
  - EC item # 61 Forecasting, #93 load forecast changes, #94 - extremes, #117 - probabilistic SARA, #119 - develop new CONE
  - EC item #72 – firm fuel, #64 – market area storage, #95 - dual fuel storage cost benefit
  - EC item # 87 – reserve margin changes needed
  - EC item #64 - microgrids
  - EC item #100 – battery performance
  - EC item #38 – winter weatherization, #65 – winter/summer weatherization, #66
  - EC item #3 – credit, #107 changes due to event, #115 QSE related credit issues
  - EC item #63 – critical infrastructure
  - EC item #82 – intermittency
  - EC item #77 – reliability requirement
  - EC item #4 – load shed practices, #33 load shed tables
15. Electric Reliability Council of Texas (ERCOT) (2021) Review of February 2021 Extreme Cold Weather event, February 25, 2021, Pages 17, 21:
16. The Perryman Group (2021), Preliminary Estimate of Economic Costs of the February 2021 Texas Winter Storm, February 2021 (low case = \$197.2B, High case= \$295.8B)
17. Potomac Economics Ltd (2011), Investigation of the ERCOT energy emergency alert level 3 on February 2, 2011, Potomac Economics serving in role of the Independent Market Monitor for the ERCOT wholesale Market.)
18. United States Department of Energy (2016) Resilience of the US Electricity System: a multi-hazard perspective.
19. Catherine Morehouse (2021), Texas PUC, ERCOT pledge “reliability is first” as state pursues market reform, Utility Dive, July 23, 2021
20. Texas, NOAA National Centers for Environmental Information, State Summaries 149-TX
21. United States Central Intelligence Agency (2019) The CIA world factbook and US Energy Information Agency (EIA) 2019 electricity consumption estimate
22. EE Online staff, (2021), Final Blackout Report, EE Online, August 27, 2021, article “...the August 14, 2003 represented the worst blackout on record for the U.S. and Canadian utility industries. According to the U.S. – Canada Power System Outage Task Force Final Blackout Report, the outage that occurred that day affected an area with an estimated 50 million people and 61,800 megawatts (MW) of electric load in eight states and the Canadian province of Ontario. The total cost estimates in the U.S. ranged between \$4 billion and \$10 billion dollars. In the Final Blackout Report, the U.S. – Canada Power System Outage Task Force identified four major outage root cause areas that included inadequate tree-trimming.”
23. US Energy Information Administration (EIA) (2020) Annual Electric Generator Report - Today in Energy, February 11, 2020
24. Gavin Blade (2017), The Great capacity market debate – which model can best handle the energy transition, Utility Dive, April 18, 2017
25. T Lynn Allen (2021), Power Failure by Design: The Texas Energy Market, American Bar Association, ABA Groups, Environmental and Energy Litigation, June 11, 2021
26. Electric Reliability Council of Texas (ERCOT) (2021), Generation by fuel type reports
27. Lincoln Laboratory, Massachusetts Institute of Technology, (2013), Interdependence of the Electricity Generation System and the Natural Gas System and Implications for Energy Security, 15 May 2013.
28. Federal Energy Regulatory Commission (FERC) – North American Electric Reliability Corporation (NERC) – Regional Entity Staff Report (2021), The February 2021 Cold Weather Outages in Texas and the South-Central United States, November 2021.
29. Federal Energy Regulatory Commission (FERC) – North American Electric Reliability Corporation (NERC) – Regional Entity Staff Report (2021), The February 2021 Cold Weather Outages in Texas and the South-Central United States, November 2021.
30. Texas Railroad Commission (2021) Emergency Order, dated February 12, 2021, Rule 2 Docket 489 temporary amendment
31. Electric Reliability Council of Texas (ERCOT) has very complex rules and a multitude of acronyms that rival those created in Washington, DC. Detailed review of the market mechanisms is beyond the scope of this document.
32. United State Department of Energy (2016), Resilience of the US Electricity System: a multi-Hazard perspective, August 18, 2016
33. T Lynn Allen (2021), Power Failure by Design: The Texas Energy Market, American Bar Association, ABA Groups, Environmental and Energy Litigation, June 11, 2021
34. Astrape Consulting (2021) Estimation of the Market Equilibrium and Economically Optimal Reserve Margins for the ERCOT Region for

## End Notes continued

- 2024 final 1/15/2021,
35. Astrape Consulting (2021) Estimation of the Market Equilibrium and Economically Optimal Reserve Margins for the ERCOT Region for 2024 final 1/15/2021,
  36. The Northbridge Group, (2017) Economic Equilibrium and Reliability in ERCOT. December 2017.
  37. United States Department of Energy (USDOE) National Energy Technology Laboratory (NETL) (2021- NETL EMAT March 15, 202 report and NETL 2020 Summer Resource Adequacy in the ERCOT region report dated May 7,2020.
  38. The Northbridge Group, (2017) Economic Equilibrium and Reliability in ERCOT. December 2017
  39. Mitch Rolling (2021) American Experiment: Wind Energy fails – Grading the reliability of energy resources during the Texas Power Outage,, February 19, 2021. "...During the EEA wind had the lowest average capacity factor (12%), lowest hourly capacity factor (2%) and lowest maximum hourly capacity (19%) of generation resources..."
  40. PJM - www.pjm.com (2018) Fuel Security Analysis: A PJM resilience assessment, December 17, 2018.
  41. Texas Railroad Commission (2020), Top 32 Texas oil and gas producers. Report dated 12-16-2020
  43. USDOE NETL (2017), ERCOT summer 2020 Resource concerning 2017 report by IHS Market.
  45. T Popik and R Humphrys (2021). The 2021 Texas Blackouts: Causes, Consequences, and Cures. Paper and presentation. The Journal of Critical Infrastructure Policy, spring/summer 2021.
  46. ERCOT (2021), Road map to improving grid reliability July 13, 2021
  47. The overlap includes
    - Primary issue overlap
      - Black start: Item #34 (review availability \_ adder of dual fuel and on-site storage),
      - Overall root cause analysis: Item #39, #80 – review of resource adequacy,
      - Microgrids: Item #64: part of harden critical infrastructure – encourage stand-alone self-contained microgrids and
      - Intermittency: Item #82
      - Fuel: #72 (firm fuel) #64 (market area storage) Dual fuel and storage: Item #95 (cost benefit of dual fuel storage and what market incentives)
      - Situational awareness: Item #56
      - Credit: Item #3 (Comprehensive evaluation of Settlement and credit worthiness requirements), #107 (changes needed based upon event), #115 (QSE related credit issues),
    - Secondary issues overlap
      - Load shed management: Item #4 (practices: practical and operational limitations), #33 (load shed tables – review methodology and obligations)
      - Outage scheduling: Item #5 (explore overall reporting and timing), #3
      - Benchmarking: Item #37 (against other RTO), #79 (similar – other RTO)
  - Winter weatherization: Item #38 (protocol review and declarations), #65 (w/s weatherization), #66
  - Weather forecasting: Item #47
  - Demand response: Item #55
  - Forecasting: Item #61, #93 load forecast changes), #94 extremes, #117 (probabilistic SARA), #119 (develop new CONE)
  - Reliability requirement: Item #77 (should there be one)
  - Critical infrastructure: Item #63 (process for identifying critical infrastructure for gas, water, and electricity)
  - Reserve margin: Item #87 (changes needed)
  - Battery performance: Item #100 (how did batteries perform)
  48. T. Lynn Allen, (2021), Power Failure by Design: The Texas Energy Market, June 11, 2021, article. Ankura ABA
  49. Texas 2012 SB 2, (2021): 8 ERCOT board members appointed by a political select committee of 3 members (governor, Lt governor and speaker), replacing members from various market sectors appointed by the members of ERCOT These 8 members must have executive experience in finance, business, engineering, trading, risk management, law or electric market design and no more than 2 academics from higher education. The ERCOT CEO will be a non-voting member of the ERCOT Board. Must be State residents.

# Affected Infrastructure Sectors

## Reports & Recommendations

---

The following reports with detailed recommendations provides a an in-depth look into the most adversely affected sector-specific infrastructure:

- Telecommunications and Fiber
- Drinking Water, Wastewater, and Stormwater
- Electricity
- Energy
- Transportation

These reports and assessments were developed to address the more unique infrastructure sector specific issues from these five areas. While there are several consistent themes and similar recommendations, each Sector report is designed to be able to stand on its own.





## Telecommunication Infrastructure

### Background

The Telecommunications Infrastructure Sector is one that includes the elimination of physical distance and other barriers to allow easy communication. The elimination of these barriers allows audio, visual, and data exchange for society to function. Everyday life, business, school, and entertainment consist of reliable data transmission. From historic signal fires and Hooke's acoustic telephone to the current use of wireless technology, we rely on the telecommunications sector to remain constantly connected, informed, and engaged. Additionally, automation of human tasks and decisions now require constant monitoring of other critical infrastructure systems that rely on this communication.

Telecommunication is **communication** at a distance using electrical signals or electromagnetic waves. Examples of telecommunications systems are:

- the telephone network
- the radio broadcasting system
- computer networks
- the Internet

Over the last 25 years, the Telecommunications Sector has evolved from being predominantly a provider of voice services into a diverse, competitive, and interconnected industry using terrestrial, satellite, and wireless transmission systems. The transmission of these services has become interconnected; satellite, wireless, and wireline providers depend on each other to carry and terminate their traffic, and companies routinely share facilities and technology to ensure interoperability.

#### How it works: **Components of a Telecommunication System**

Telecommunication is the transmission of information such as words, sounds, or images, usually over great distances, in the form of electromagnetic signals, as by telegraph, telephone, radio, or television. Modern-day telecommunication system is best described in terms of **a network**.

In its most fundamental form, a telecommunication system includes a *transmitter* to take information and convert it into a signal, a *transmission* medium to carry the signal and a *receiver* to take the signal and convert it back into usable information. This applies to any communication system, whether it uses computers or not.

This includes the basic elements listed previously, but also the infrastructure and controls needed to support the system. There are *six basic components* to a telecommunications network.

1. Input and output devices also referred as 'terminals'. These provide the starting and stopping points of all communication. A telephone is an example of a terminal. In computer networks, these devices are commonly referred to as 'nodes' and consist of computer and peripheral devices.





## Telecommunication Infrastructure

2. Telecommunication channels, which transmit and receive data. This includes various types of cables and wireless radio frequencies.
3. Telecommunication processors provide several control and support functions. For example, in many systems, data needs to be converted from analog to digital and back.
4. Control software, which is responsible for controlling the functionality and activities of the network.
5. Messages represent the actual data that is being transmitted. In the case of a telephone network, the messages would consist of audio as well as data.
6. Protocols specify how each type of telecommunication system handles the messages. For example, GSM and 3G are protocols for mobile phone communications, and TCP/IP is a protocol for communications over the Internet.

While early telecommunication systems were built without computers, almost all systems our society uses today are computerized in some way.

### What are the Different Types of Telecommunications Technology?

Telecommunications technology includes any method used by humans to communicate information over a distance.

The systems we currently use for communicating at a distance through electrical signals or electromagnetic waves include:

- the telephone network
- the television and radio broadcasting system (replaced the telegraph)
- computer networks
- the Internet

each with its own unique properties to benefit the information exchange of humankind.

### Phone Networks

Today, one of the most prevalent telecommunications devices is the telephone, an instrument that transfers vocal information from one geographic location to another. Two main types of phones used in modern society are:

- the analog-based, fixed-line telephone; and
- the satellite-based, cellular phone

Fixed-line telephones were first established as a telecommunications network in the late 1800s using a complex system of wires placed around the world. Cellular technology was first implemented in the 1970s using a network of satellites and radio towers.

## Telecommunication Infrastructure

### Fax Machines

Fax machines, which utilize the fixed-line telephony network, also use the same method to transfer paper-based information.

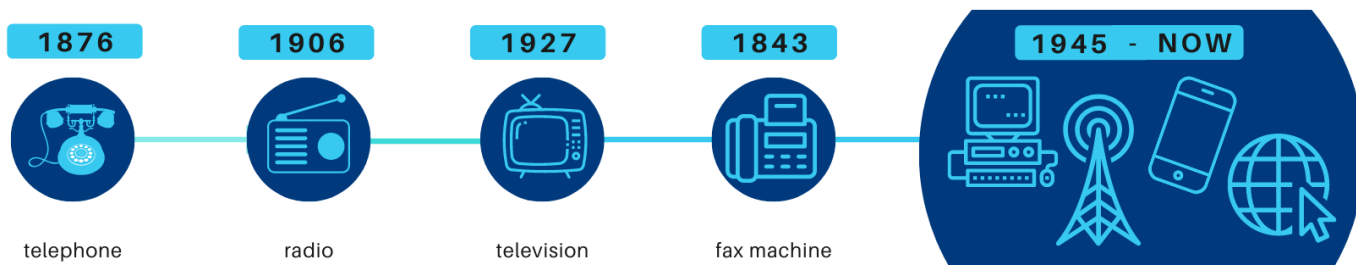

### Radio and Television Network

The broadcast system, which features the radio and television networks, uses a different format to transmit information. Both systems use electromagnetic waves that send audio and video information from one location to another. This can either be accomplished through an analog or digital method. The basic methodology for both principles was created during the early 1900s and quickly became primary methods of information transfer throughout the next century. One challenge with this form of technology is the fact that different frequencies are used for different platforms and locations around the world.

### Computer Networks

Networked computers are common in the modern world and are either connected to a local-area network (LAN) or the world wide web (www). This telecommunications technology allows users to send and receive a variety of formatted information such as text via emails or video with webcams. Different types of connections are available to make this technology function. Early connective techniques included fixed-line analog-to-digital modems, while newer methods included Ethernet lines and wireless connections using electromagnetic waves.

### Telecommunications Interconnectedness with Other Infrastructure Sectors

Telecommunication is an inseparable part of every critical infrastructure sector. Utilities rely on supervisory control and data acquisition (SCADA) system for monitoring, maintenance and control. Financial institutions, healthcare, military and government sectors rely upon proper functionality of the telecommunications sector to be effective, protect the public, and manage communities.

The interconnectedness of telecommunication systems has not only revolutionized and made systems more efficient, on the other side interdependency among the various sectors has also introduced new potential threats from natural disasters and deliberate cyber-attacks which can threaten and disrupt operations and public safety. According to Homeland Security “there are 16 critical infrastructure sectors whose assets, systems, and networks, whether physical or virtual, are considered so vital to the United States that their incapacitation or destruction would have a debilitating effect on security, national economic security, national public health or safety, or any combination thereof.”



## Telecommunication Infrastructure

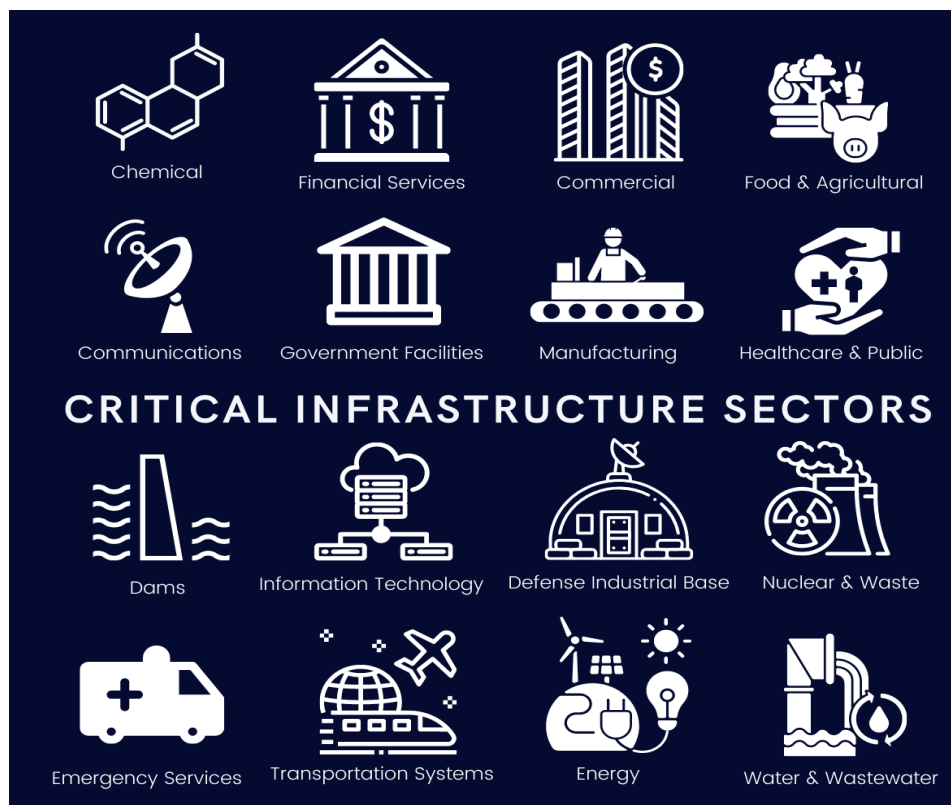

Source: U.S. Department of Homeland Security

The telecommunications industry must cope with the fast pace of technology, the global scope of its networks, ever-increasing traffic, and customer expectations of round the clock, faultless service at a reasonable price. All these factors result in many technical and operational challenges for the telecom industry. Some of the most significant challenges are:

- Functional readiness at constantly increasing frequencies.
- Reliability and lifetime testing under field conditions.
- Maximizing performance while minimizing costs.

Telecommunication devices have an insatiable appetite for data which demand ever-greater bandwidths. Although the telecommunication devices may be more compact, they often require larger arrays of elements, which adds complexity when evaluating the expected system-level lifetime of a transmitter.

As it pertains to reliability, it is important for base station amplifier manufacturers to test their devices under conditions as close as possible to the conditions they will experience in the field. The challenge is to conduct application-specific testing in a lab at high power levels with sufficient temperature control to dissipate high power while accurately recreating the worst-case ambient conditions expected in use.



## Telecommunication Infrastructure

Telecom networks need to be scalable enough to accommodate future growth, at least for the medium term. Growth implies more end devices running more applications that require greater bandwidth, predictable response times, and low latency.

For the telecommunications sector to be resilient, a couple of factors are at the forefront:

- Service access (Availability)
- Performance (Speed of service)

### Why is the Telecommunications Sector Important?

The Communications Sector is an integral component of the U.S. and state economies, underlying the operations of all businesses, public safety organizations, and government. Presidential Policy Directive 21 identifies the Communications Sector as critical because it provides an “enabling function” across all critical infrastructure sectors.

In Texas, experts say more than nine million people are without a broadband internet connection, either because the infrastructure does not reach their homes or because they are unsubscribed to a service. The state is one of six that does not have a broadband plan (i.e., a roadmap to address the digital divide).

The state’s telecommunications infrastructure is fundamental to its society and a local, state and national plan can help local governments and citizens respond efficiently during major natural disasters. Efficient responsiveness to the most basic administrative functions will help the economy and to save lives.

### Which agencies govern telecommunications in Texas?

Created in 1975, The Public Utility Commission of Texas (PUC or PUCT) is a state agency that regulates the state’s electric, water, and telecommunication utilities. The PUCT also implements respective legislation and offer customer assistance in resolving consumer complaints.

Appointed by the Texas Governor, the three-member commission also regulates the rates and services of transmission and distribution utilities that operate where there is competition, investor-owned electric utilities where competition has not been chosen, and incumbent local exchange companies that have not elected incentive regulation.

The PUC’s mission is to “protect customers, foster competition, and promote high quality infrastructure.”

### Telecommunications at-a-glance

The percentage of U.S. adults who own a smartphone has more than doubled since 2011. Only 35% of all U.S. adults owned a smartphone in 2011, compared to 85% of adults who owned a smartphone, as of February 2021. The share of U.S. adults owning a smartphone increased by 50% from 2011 to 2021.

The U.S. Census Bureau statistics for 2015-2019 indicate that households with a computer is 91% and households with a broadband internet subscription is 81.9%.



### What problems occurred with telecommunications during the Winter Storms 2021?

The North American Winter Storm (Winter Storm Uri) period extended from February 13-17, 2021, which caused widespread impact across the country, and Texas power crisis.

- Power outages (widespread blackout for prolonged durations)
- Unreliable to no cell phone service (inability to make or receive calls or text messages)
- Impacted radio broadcast stations

By February 15, 2021, cell phone service providers were reliant on social media to communicate to their users that they were working diligently to restore service. In some cases, the power outages impacted the fiber that the cell phone service providers use to provide connectivity from each cell site to their switching facilities. In other cases, the frigid temperatures impacted the infrastructure. Cell services depend on antennas and base stations to connect calls between towers.

Every dominant certificated telecommunications utility (DCTU) is required to file an Emergency Operations Plan with the Commission. These plans, required pursuant to regulations promulgated under Public Utility Regulatory Act (PURA) §§ 55.001 – 55.003, ensure adequate telecommunications provider planning for weather-related or security-related emergencies.

The State of Texas Emergency Management Plan (TDEM) is currently revising the Emergency Support Function Annex for Communications (ESF 2).

To rely on a resilient telecommunication sector, the following recommendations are offered:

- Pro-rated cost participation by the telecommunication service providers in winterization of electric grid to avoid prolonged periods of time without power.
- Transparent Emergency Operations Plan for telecommunication service providers.
- Emergency Operations Plan for all telecommunication service providers.

### Proposed Recommendations for a Resilient Telecommunications Sector

1. **Improved hardening of site telecommunication facilities/infrastructure for weather extremes:** The impacts from Winter Storms Uri and Viola were severe and often exceeded scenario assumptions for telecommunication facilities and infrastructure. This requires greater preparedness for harsh weather conditions in the future. A comprehensive review of specific issues experienced including the identification of risk areas for improved maintenance and modernization efforts.
2. **Consider expanded redundancy of select infrastructure:** Develop plans to include redundancy in key quality of life infrastructure sectors (e.g., power and water) to be reviewed and approved by PUCT.
3. **Education and outreach to interdependent infrastructure.** Telecommunication drives business and the safe and reliable operation of critical infrastructure relied upon by society and business. Develop renewed and updated risk mitigation plans with operators of critical infrastructure to identify steps and potential redundancy investments that can be made and deployed that can mitigate the potential loss of situation awareness and control of their systems. Ensure regular testing of public outreach by governmental agencies during emergencies under stressed scenarios.



## Telecommunication Infrastructure

### Sources

- <https://study.com/academy/lesson/the-components-of-a-telecommunications-system.html>
- <https://www.easytechjunkie.com/what-are-the-different-types-of-telecommunications-technology.htm>
- <https://www.puc.texas.gov/industry/communications/Default.aspx>
- <https://www.statista.com/statistics/219865/percentage-of-us-adults-who-own-a-smartphone/>
- <https://www.census.gov/quickfacts/fact/table/TX/PST120219>
- <https://www.theverge.com/2021/2/15/22284309/texas-winter-storms-internet-cell-network-issues-t-mobile-att-spectrum>
- [Critical Infrastructure Sectors | CISA](#)
- [Reliability in the Telecommunications Industry | Accel RF | Reliability Testing for Compound](#)
- [fg-dnrrr-tech-rep-2014-6-NRR-requirement.pdf \(itu.int\)](#)
- [Texas Broadband Briefing Book - April 2020.pdf](#)
- [1 The Importance of Telecommunications and Telecommunications Research | Renewing U.S. Telecommunications Research | The National Academies Press \(nap.edu\)](#)
- [National Broadband Map | BroadbandNow](#)
- <https://www.asentria.com/blog/preparing-telecom-network-for-weather-related-disasters/>
- <https://www.nyclimatescience.org/sectors/telecommunications>
- <https://tradingeconomics.com/united-states/telecommunications-revenue-percent-gdp-wb-data.html>



## Water, Wastewater, and Stormwater

### Background of Water, Wastewater and Stormwater Operations (Water Resources)

#### Drinking Water

The State of Texas had 7,056 water systems serving 29,096,493 people in 2019. A map of PWSs generated by information provided by the Texas Commission on Environmental Quality (TCEQ) is shown in Figure 1. Of these systems, 79.5% were groundwater and 20.5% were surface water systems (TCEQ, 2020). Water treatment of a typical groundwater systems consists primarily of disinfection before being delivered to the customer. Water treatment of surface water is more complex and typically consists of settling, filtration, and disinfection, the amount of which is dependent on the source water quality. To maintain minimum water pressures, utilities provide elevated storage tanks and/or pumping from ground storage tanks.

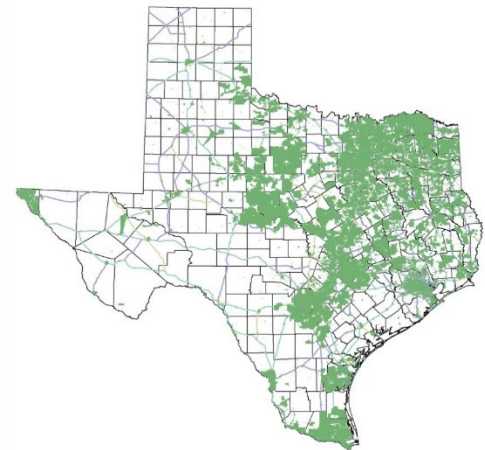

Figure 1. Texas Public Water Systems

The 7,056 water systems are classified by size in Table 1. Approximately 95% of the systems individually serve 10,000 people or less, representing 25% of the population of Texas. Conversely, the large and very large systems serve approximately 75% of the population.

Table 1. System Size Classification

EPA Classification	Population Served	Number of PWS	Total Population Served
Very Small	25 - 500	4,227	674,834
Small	501 - 3,300	1,769	2,581,170
Medium	3,301 - 10,000	702	3,974,511
Large	10,001 - 100,000	317	7,998,408
Very Large	Over 100,000	41	13,867,570
	<b>Total</b>	<b>7,056</b>	<b>29,096,493</b>

Source: State of Texas Public Drinking Water Program 2019 Annual Compliance Report

#### Wastewater

Currently there are 3,876 wastewater outfalls in the State (TCEQ, 2021). A map of wastewater outfalls from the TCEQ is shown in Figure 2. Wastewater treatment associated with these outfalls typically consists of screening, a form of biological treatment, sedimentation, and disinfection. The size and complexity of the wastewater



## Water, Wastewater, and Stormwater

treatment is primarily dependent on the amount of wastewater to be treated. Individuals with private water supply or that are on rural water systems typically utilize septic systems.

The ASCE Infrastructure Report Card for Texas was updated in 2021. Grades were developed for Drinking Water and Wastewater. Grades for stormwater were also developed in two areas, Flood Risk Management and Levees. Texas' drinking water sector has improved in the conservation, planning, management, and increases in State funding and financing support resulting in a Texas Infrastructure Report card score C-, an improvement from the 2017 grade of D-. The condition of wastewater systems, on the other hand, are not improving, primarily because of their age and deficient Federal and State funding resulting in a Grade of D, no change from the 2017 grade (Texas Section ASCE, 2021).

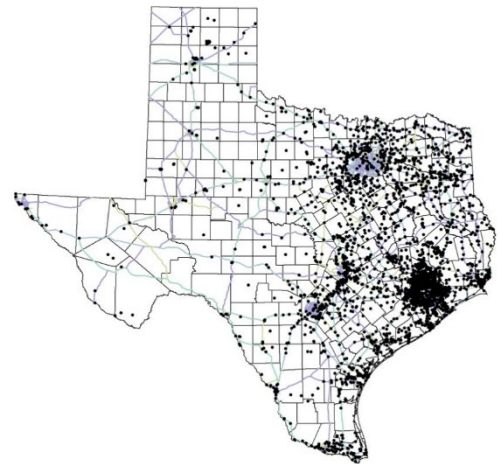

Figure 2. Texas Wastewater Outfalls

### Stormwater

Rainwater falls on the ground and makes its way to waterways, streams, lakes, and the gulf via overland flow and sometimes via a complex system of various storm drain infrastructure, including but not limited to inlets, pipes, tunnels, detention and retention ponds, reservoirs etc. When a large amount rain falls during a short period of time, also known as high intensity rainfall, or during an extended period, storm water overwhelms the capacities of the natural and manmade conveyance system, and we experience flooding.

Since Hurricane Harvey dumped 34 trillion gallons of rain over Texas, affecting 30% of the Texas population and causing \$125 billion in damages, there has been a lot of positive momentum to work towards reducing the risk and impact of flooding in the state.

In 2017, the ASCE Infrastructure Report Card for Texas graded stormwater under the title of “Flood Control” and received a grade of D. In the 2021 Report, Stormwater was graded in two distinct areas, “Flood Risk Management” with a grade of C- and “Levees” with a grade of D.

Based on research of news articles, there has not been any widespread reporting of flooding due to precipitation during or because of the 2021 winter storm event. However, there was localized flooding from broken water distribution infrastructure, which is also reflected in the survey of utilities included in the later part of this report. It is important to explore the need to be prepared for potential flooding associated with future winter storm events and assess what needs to be done to avoid and minimize the impact of flooding in such events.

### Interconnectedness with other Utility Sectors

Water Resources (i.e., water, stormwater, and wastewater) cannot be looked at in a vacuum. Other infrastructure sectors influence and impact water resources and vice versa.

The other infrastructure sectors include but are not limited to transportation, energy, and communications. The transportation sector's influence on water resources consists of the traffic volumes





## Water, Wastewater, and Stormwater

along roads and railways moving chemicals used in the water and wastewater treatment processes and the operation and maintenance of infrastructure and equipment. Water resources can be impacted by roadway and rail construction, accidents, and inclement weather.

Dependency on the energy sector referred to as the water-energy nexus represents the relationship between how much energy is necessary to collect, clean, move, store, and dispose of water, as well as how much water is used to generate and transmit power.

Despite this interdependence between the sectors, water and energy systems have been developed and managed independently. Most water utilities have established points of contact with their electric delivery provider to identify critical facilities within the water utility.

Water utilities utilize both wired and wireless communications to collect and transmit system and operations data and for communications with customers. Wireless communication activities in the water resources sector are increasing and will be impacted by band width limitations and communication speeds.

*“Present day water and energy systems are interdependent. Water is used in all phases of energy production and electricity generation. Energy is required to extract, convey, and deliver water of appropriate quality for diverse human uses, and then again to treat wastewaters prior to their return to the environment.”*

*-U.S. Department of Energy 2014 The Water-Energy Nexus: Challenges and Opportunities Overview and Summary*

## Water Infrastructure Resiliency

In accordance with TCEQ Subchapter D: Rules and Regulations for Public Water systems, water systems are required to be designed to maintain a minimum pressure of 35 psi at all points within the distribution network at flow rates of at least 1.5 gallons per minute per connection. When the system is intended to provide firefighting capability, it must also be designed to maintain a minimum pressure of 20 psi under combined fire and drinking water flow conditions (30 TAC §290.44(d)). Water systems must also be designed to meet the requirements of 30 TAC §290.45(h), relating to minimum water system capacity requirements.

The American Water Works Association (AWWA) Policy Statement on Electric Power Reliability for Public Water Supply and Wastewater Utilities states that every water and wastewater utility should set uninterrupted service as a high priority operating goal. To maintain the required levels of service, water, stormwater, and wastewater utilities engage in some level of “all hazards” risk assessment and planning, an approach that includes the full spectrum of occurrences that could happen, without focusing on specific risks such as malicious acts or natural disasters. The emphasis is on developing multi-hazard response capacities that address the most common risks for the utility but also provide capacity to respond to less likely risks.

The America’s Water Infrastructure Act of 2018 (AWIA) requires systems that serve more than 3,300 people (i.e., 14% of water utilities serving 89% of the population) to complete a risk and resilience assessment (RRA), develop an emergency response plan (ERP) and certify to the U.S. Environmental



**Water, Wastewater, and Stormwater**

Protection Agency (EPA) that they have done so. RRA and ERP must be updated and recertified every five years.

The AWWA published AWWA Manual M19, *Emergency Planning for Water Utilities* (Gay et. al, 2018), providing guidelines and procedures that can be used by water utilities in preparation for emergencies and disasters. Documented therein are summaries of potential hazards, as well as identification of common water system components and how each may be vulnerable. A range of mitigation actions that can be taken to decrease the vulnerability of components is then discussed, along with considerations of the costs and benefits of such actions. Emergency preparedness plans are presented along with discussions on training, techniques, and regulatory requirements. Importantly, the concepts of emergency response, recovery, and training are presented in the specific context of water utility operations, offering informative and applicable examples of the considerations water utilities must implement to effectively manage emergency situations.

Presented in Table 2 below are a suggested list of major components of a water system. The extent of detail available on each component greatly informs the characterization and assessment of that component’s vulnerability to a given hazard.

Broadly, the vulnerability assessment process described in AWWA M19 (2018) entails specifying the components of a given water system, characterizing the likelihood and effects of hazards on each of the various components comprising a water system, identifying (or establishing) performance goals for the acceptable levels of service for the system, and identifying key or critical system components most vulnerable to failure or partial failure because of a disaster hazard. Vulnerable components can then be rendered less susceptible to harm through mitigation actions intended to eliminate or reduce the damaging effects of disasters. AWWA Manual M19 (2018) presents four questions to be considered prior to implementing mitigation actions:

1. How critical is the component to the system?
2. What is the age of the component?
3. What are present and projected expansion, replacement, or construction programs?
4. What is the cost of the mitigation action?

Presented therein are several potential mitigation measures for each category of water utility system components. Information developed in this process can then be used to develop the ERP. Suggested elements include overall goals and objectives, the identification of elements or triggers for ERP activation supporting rapid response, a preset list of activities to be undertaken, a communication chart, agreements with other agencies or organizations, disaster-specific plans (where appropriate), disaster recovery accounting, a distribution list of individuals with the plan, and the establishment of procedures for updating the ERP going forward.

**Table 2. Major Water System Components**

<p><b>Administration and operations</b></p> <ul style="list-style-type: none"> <li>• Personnel</li> <li>• Facilities and equipment (buildings and computers)</li> <li>• Records (accounting, customer lists, system maps)</li> <li>• Emergency plan</li> </ul>	<p><b>Distribution system</b></p> <ul style="list-style-type: none"> <li>• Pipelines, valves, and other appurtenances</li> <li>• Pump or pressure-reducing stations</li> <li>• Materials (extra pipe, valves, hydrants, etc.)</li> </ul>
<p><b>Source water</b></p>	<p><b>Electric power</b></p>



**Water, Wastewater, and Stormwater**

<ul style="list-style-type: none"> <li>• Watersheds and surface water sources</li> <li>• Reservoirs and dams</li> <li>• Groundwater sources</li> <li>• Wells and galleries</li> </ul>	<ul style="list-style-type: none"> <li>• Substations</li> <li>• Transmission lines</li> <li>• Transformers</li> <li>• Standby generators</li> </ul>
<p><b>Transmission system</b></p> <ul style="list-style-type: none"> <li>• Intake structures</li> <li>• Aqueducts</li> <li>• Pump stations</li> <li>• Pipelines, valves, and other appurtenances</li> </ul>	<p><b>Transportation</b></p> <ul style="list-style-type: none"> <li>• Vehicles (including construction equipment)</li> <li>• Maintenance facilities</li> <li>• Supplies, spare parts, and fuel</li> <li>• Roadway infrastructure</li> </ul>
<p><b>Treatment facilities</b></p> <ul style="list-style-type: none"> <li>• Facility structures (buildings, basins, and tanks)</li> <li>• Controls (manual and computer)</li> <li>• Equipment (feeder, pumps, and piping)</li> <li>• Chemicals</li> </ul>	<p><b>Communications</b></p> <ul style="list-style-type: none"> <li>• Telephone</li> <li>• Radio</li> <li>• Telemetry</li> <li>• Mass media outlets (newspaper, radio, television)</li> </ul>
<p><b>Storage</b></p> <ul style="list-style-type: none"> <li>• Tanks</li> <li>• Valves</li> <li>• Piping</li> </ul>	

Source: AWWA M19, 2018

Seven general steps are recommended within AWWA Manual M19 (2018) for when an emergency strikes a system (or systems).

1. Analyze the type and severity of the emergency.
2. Provide emergency assistance to save lives.
3. Reduce the probability of additional injuries or damage.
4. Perform emergency repairs based on priority demand.
5. Return system to normal levels (recovery).
6. Evaluate response and preparedness plan.
7. Revise plan as necessary.

The information provided in the AWWA Manual M19 (2018) provides an excellent framework from which to begin considering recent emergency events experienced in the state of Texas.

**Winter Storm Uri February 2021 Events**

Winter storm Uri occurred between February 13-17, 2021. The storm included major ice and snow for much of the United States. There were various winter weather alerts and the storm caused blackouts for millions of people, including significant power issues in Texas.

Leading up to the week of the storm, water utilities were aware of the likelihood that temperatures would drop below freezing for days. Preparations were made to protect infrastructure from the freezing temperatures. Utilities issued alerts to customers to remember to drip their faucets and open their under-sink cabinet doors to keep premise plumbing from freezing. As the temperatures dropped and water demands increased due to customers’ utilization of water for dripping their faucets along with private premise plumbing breaks and main breaks, many water utilities had to treat and distribute water to meet demands that abnormally reached or exceeded peak summer day levels. Many water utilities had to bring additional water treatment on-line. These unseasonable demands required a more rapid



**Water, Wastewater, and Stormwater**

use of stored chemicals utilized in the water treatment process. These chemicals were difficult to procure for some utilities due to the inability to obtain deliveries.

Ice accumulation caused by the precipitation and unusually cold temperatures for Texas, in addition to rolling blackouts and extended duration power outages at critical facilities, caused widespread disruptions to water and wastewater infrastructure across the State, affecting a significant number of components of these systems in multiple categories. Water line breaks occurred in many areas, and power disruptions impacted water treatment plants in parts of the region that forced many cities including Houston, San Antonio, Fort Worth, Abilene, Austin, Killeen, and Arlington, as well as many smaller cities and other water providers to issue boil-water notices. In total, 2,321 public water systems issued boil water notices, of which 1,985 were community public water systems affecting a population of 17,876,538. The boil water notices issued were a direct result of the storm relating to power loss, damaged equipment, loss of pressure, or dangerous road conditions. The first boil water notice issued in the state was on February 16, 2021, and the last boil water notice lifted was on March 13, 2021. Compounding the problem was the lack of power to boil water, leading to shortages of bottled water in grocery stores.

“Nearly 40% (1,985) of community public water systems had issued a boil water notice at the peak of Winter Storm Uri.”

- Texas Commission of Environmental Quality, November 18<sup>th</sup>, 2021, *After-Action Review of Public Water Systems and Winter Storm Uri*.

**Findings from Utility Survey**

To gain greater insights into the specific challenges faced during the winter storm, a high-level, informal survey of Texas water utilities was performed by the Water Resources Subcommittee of the Task Committee. Participation in this survey was entirely voluntary, and the information obtained from those that participated (70 surveyed, 16 respondents, 22% response rate) offers useful elements for consideration herein.

Of the 16 respondents, all served system populations greater than 3,300, with 9 respondents serving populations greater than 100,000. All but one survey respondent provided water service, 11 provide wastewater, and 6 provide stormwater.

● Less than 500	0
● 501 to 3,300	0
● 3,301 to 10,000	1
● 10,001 to 100,000	7
● Over 100,000	9



**Figure 3. Survey Respondents Population Served**



**Water, Wastewater, and Stormwater**

<span style="color: blue;">●</span> Water	15
<span style="color: orange;">●</span> Wastewater	11
<span style="color: green;">●</span> Stormwater	6



*Figure 4. Survey Respondents Services Provided*

**Activities Performed Before, During and After the Storm**

The results of the survey were instrumental in identifying activities performed by utilities before, during, and after winter Storms Uri and Viola.

Preparation does not begin days or weeks before an event but years before an event occurs. Many water utilities have instituted aggressive leak detection and main replacement programs. Dallas Water Utilities instituted their leak detection and rehabilitation program twenty years prior to the winter storm. Utilities participating in the survey indicated that they have been systematically removing cast iron pipes from their systems, resulting in fewer water main breaks during cold weather.

Preparation does not begin days or weeks before an event but years before an event occurs.

Additionally, water utilities indicated that their efforts to install backup generators allowed them to operate equipment during the power outages. Advance winterization efforts helped to control the freezing of necessary infrastructure at lift stations and treatment plants.

Utilities with Automated Metering Infrastructure (AMI) indicated that AMI proved to be very valuable in locating premise leaks. The rapid identification of these leaks allowed water utilities to quickly address private-side water loss in the overall water distribution system and to maintain system pressure.

Table 3 provides a compilation of activities performed by water utilities throughout the State leading up to, during and after the winter storm.

**Table 3. Winter Storm Preparation, Management and Recovery**

Prior to Winter Storm Event	Activities
Greater than 6 months	<ul style="list-style-type: none"> <li>● Develop and maintain a Risk and Resilience Assessment and Emergency Response Plan</li> <li>● Install backup generation and dual power feeds to critical facilities</li> <li>● Implement leak detection and pipe replacement programs</li> <li>● Upgrade communication equipment</li> <li>● Install advanced meeting infrastructure</li> <li>● Acquire or upgrade equipment suitable for emergency situations</li> </ul>
Within 6 months	<ul style="list-style-type: none"> <li>● Winterize equipment and facilities</li> <li>● Issue cold weather clothing (coveralls, coats, hats, gloves, etc.) to field employees</li> </ul>



**Water, Wastewater, and Stormwater**

Prior to Winter Storm Event	Activities
Days before	<ul style="list-style-type: none"> <li>• Verify earlier winterization efforts</li> <li>• Implement additional freeze protection practices</li> <li>• Test back-up lines and equipment</li> <li>• Revise staffing schedules</li> <li>• Increase communications with staff</li> <li>• Top off elevated and ground storage tanks</li> <li>• Assign staff to infrastructure and areas for possible manual operation.</li> <li>• Top off supplies (i.e., fuel, chemicals for water, etc.)</li> <li>• Sand roads within treatment facilities</li> <li>• Issue public announcements to prepare for freezing temperatures (i.e., drip faucets, open cabinet doors, etc.)</li> </ul>
During	<ul style="list-style-type: none"> <li>• Continue to provide water, stormwater, and wastewater services</li> <li>• Meet unseasonable water and wastewater demands (demands increasing to summertime levels)</li> <li>• Bring additional treatment capacity on-line</li> <li>• Continue water quality testing</li> <li>• Dispatch crews to manually operate various system valves to redirect and sustain flow to reservoirs and pump stations impacted by electrical outages</li> <li>• Request wholesale customers to reduce demands</li> <li>• Identify and repair main breaks</li> <li>• Identify private main breaks</li> <li>• Assist customers with private water shut offs due to private premise plumbing breaks</li> <li>• Increase 24/7 emergency call center capacity</li> <li>• Secure hotel accommodations for field staff</li> <li>• Secure and supply food and supplies for staff</li> <li>• Maintain and repair heat tracing and insulation of above ground pipes</li> <li>• Utilize backup generation</li> <li>• Continue to refuel generators</li> <li>• Issue “Boil Water Notice”</li> <li>• Provide bottled water and /or water filling stations</li> <li>• Refill water storage tanks and reservoirs</li> <li>• Disconnect individual residential and commercial water meters when leaks were identified by AMI or customer request</li> </ul>
After	<ul style="list-style-type: none"> <li>• Continue to identify and repair main breaks</li> <li>• Work with customers to turn on water when private side repairs are made</li> <li>• Repair and replace equipment damaged by the storm</li> <li>• Dispatch water trucks and distribute bottled water</li> <li>• Retrofit fire hydrants for bulk water filling</li> <li>• Provide water bill relief</li> <li>• Develop an after-action report</li> </ul>



## Water, Wastewater, and Stormwater

### Problems and Vulnerabilities Experienced by Texas Water Utilities

Analysis of reported issues indicates a suite of problems and vulnerabilities experienced by Texas water utilities because of the winter storm. These issues have been compiled and ranked by impact as presented in Table 4. These were identified as the most significant impacts; the distinction between high and medium represents the relative contribution to widespread system outages and boil water notices.

**Table 4. Ranking of Problems by Impact**

No.	Problem	Consequence	System Impact	Cascade
1	Unreliable power supply to utilities	Interrupted pumping and loss of water supply	High	
2	Extended power outages to individual customers	Frozen plumbing resulting in premise plumbing pipe breaks, loss of water, property damage, and repair costs incurred by customers	High	
3	Higher than normal customer demand	Inability to meet high water demands, pressure reduction in the system, and Boil Water Notices	High	Cascade from 2
4	Water main breaks	Water supply interruption and increased demand	Medium	
5	Large number of water shutoffs	Staff working around the clock for days	Medium	Cascade from 2
6	Loss of SCADA* communications	Inability to monitor system operation in real time	Medium	
7	Impassable streets	Crews unable to access facilities	Medium	
8	Interrupted water supply	Customers without water for days	High	Cascade from 2, 3, and 4
9	Chemical supply interrupted	Water treatment interrupted	High	Cascade from 7
10	Sudden power supply interruption (lack of electrical utility coordination with water utilities)	Sudden stoppage of pump stations caused water hammer and over pressurization of water distribution lines resulting in main breaks	High	Cascade from 1

\* Supervisory Control and Data Acquisition (SCADA)



## Water, Wastewater, and Stormwater

### What Worked Well

The survey respondents indicated that there were also aspects of water utilities’ response to the winter storm that worked well, including:

- Utility pre-planning and exercises for emergency events.
- Existing availability of backup power/generators.
- Prior replacement of cast iron pipes.
- Existing leak adjustment or forgiveness programs for customer financial assistance.
- Automated Metering Infrastructure technology ability to help locate private plumbing leaks.
- Utility staff commitment to work around the clock for days.
- Assistance from Fire Departments to turn off water at locations where premise pipes were broken.

### Water and Wastewater System Performance

In addition to providing qualitative comments on the topics discussed above, survey respondents also provided performance ratings for their water and wastewater systems and impact ratings for their stormwater systems.

*Question: In general, how did your system perform?*

Very poor Poor Fair Good Excellent N/A

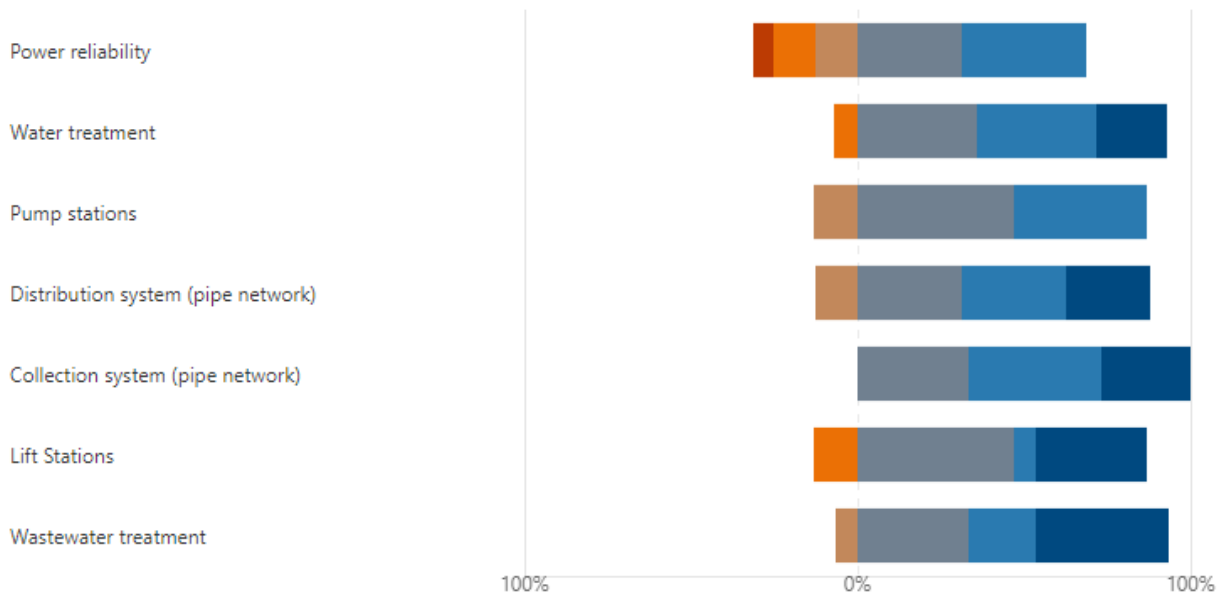

Figure 5. Survey Respondents System Performance





**Water, Wastewater, and Stormwater**

**Impact on flooding, stormwater, and flood control infrastructure**

Survey respondents reported minimal flooding, stormwater, and flood infrastructure impact due to the winter storm.

*Question: For stormwater systems, did the winter storm impact flooding, stormwater, and flood control infrastructure?*

None Minimal Some Significant N/A

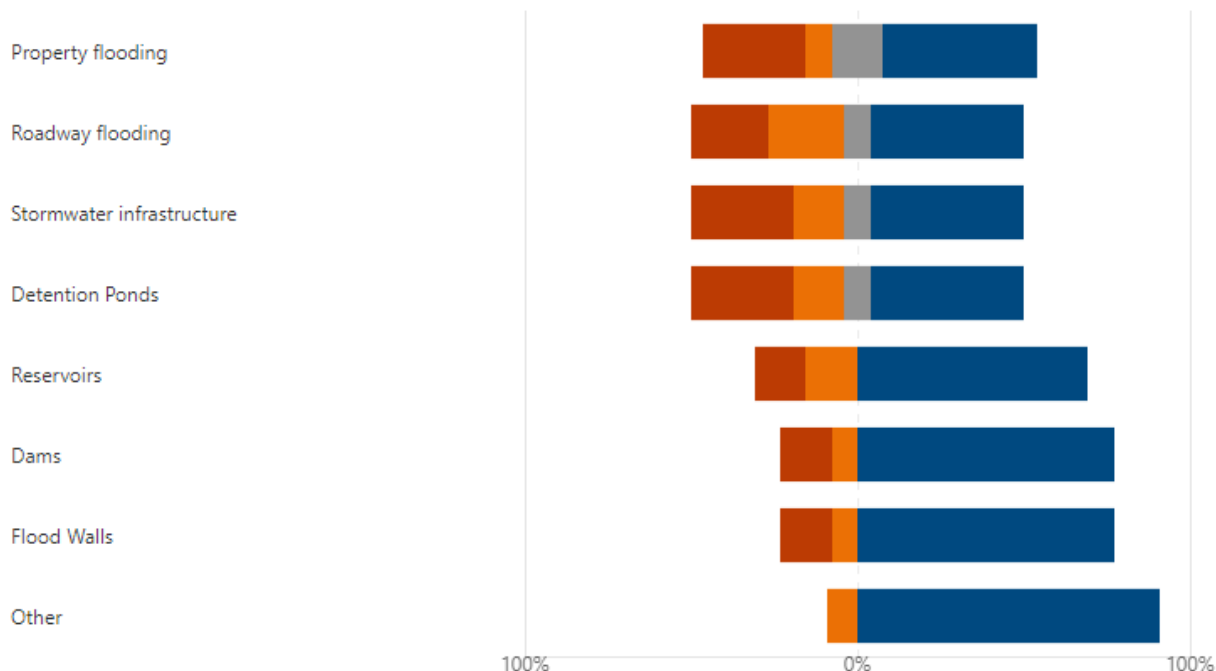

**Figure 6. Survey Respondents Stormwater Impacts**

**Critical Problems**

The Water Resources Subcommittee of the Task Committee evaluated the major causes of the widespread water outages and boil water notices that affected millions of Texans during the winter storm. The primary drivers can broadly be categorized as inadequate treatment capacity and excessive demand.

Inadequate treatment capacity resulted from treatment capacity being off-line, primarily due to planned winter maintenance and freeze-related damage to piping and equipment, and chemical delivery interruptions, primarily due to hazardous road conditions. Additionally, power outages at some water treatment facilities caused temporary cessation of treatment entirely until power was restored, and operational units could be methodically brought back on-line and ramped up to full capacity.

Excessive demand resulted from private plumbing failures, pump station interruptions, and water main breaks. Private plumbing failures can be attributed to the extended freezing temperatures and widespread power outages, which contributed in two ways, the inability of customers to access public messaging on preparedness (e.g., dripping faucets and insulating hose bibs) and freezing temperatures in private dwellings due to extended periods without heat. Pump station interruptions were caused by



## Water, Wastewater, and Stormwater

a variety of factors, including inadequate backup power generation and pre-existing issues of insufficient pumping capacity due to equipment out of service for winter maintenance. Additionally, road conditions prevented utility staff from deploying portable generators to some locations. Water main breaks were primarily attributed to small diameter aged, brittle pipe (e.g., cast iron) breaks caused by freezing temperatures and pressure surges from pump station power outages.

This analysis is illustrated in Appendix A. Additional contributing factors included SCADA communications interruptions and staff safety and transportation impacts. As shown, the primary root causes were treacherous road conditions and power outages resulting from the extended period of freezing temperatures.

### Recommended Actions

Based on the results of the survey, the root cause analysis, and the experience of this committee, the following recommendations have been compiled.

1. Consider increasing the amount of treatment capacity available during the winter months.
2. Consider increasing the number of backup generators, including portable backup generators on trailers and portable diesel pumps. Install auto transfer switches on generators.
3. Consider implementing backup power for SCADA communications.
4. Consider increasing bulk chemical storage.
5. Educate public on the need for 72 hours of supplies for emergencies.
6. Educate customers on locating and operating their premise water shutoff valves.
7. Replace cast iron pipes with a history of poor performance.
8. Ensure access to all weather vehicles. Utilize fuel additive for diesel during winter months. Acquire and store tire chains, then distribute to appropriate vehicles prior to winter weather.
9. Top off water supply storage prior to a winter storm event.
10. Conduct winter weather preparation at facilities, such as pipe insulation, draining non-critical piping, storing strap-on boot spikes, bedding, MREs. Ensure manual access to critical facilities, such as walk-through gates.
11. Include emergency response to the list of benefits when justifying Automated Metering Infrastructure implementation.

### Observations and Recommendations

**(1) Observation:** Utilities in Texas historically experience lower demands during winter months and utilize that time to perform required maintenance at treatment plants and water pumping and storage facilities. During the winter storm, this reduced utilities capacity to produce and distribute water to meet demands that were as high or higher than typical summer peak demands.

**Recommendation:** Consider increasing the amount of treatment capacity available during the winter months, based on updated demand planning criteria for winter months. Identify and implement improvements at production and pumping facilities that would provide additional flexibility in scheduling required maintenance.

**(2) Observation:** Power outages at water and wastewater treatment plants, pump stations, and lift stations resulted in reduction of water production capacity, loss of water storage, and sanitary sewer overflows. Utilities operated permanent generators and deployed portable generators to provide



## Water, Wastewater, and Stormwater

temporary power, but the effectiveness of generators was impacted by access issues that prevented refueling permanent generators and transporting portable generators. Additionally, freezing weather damaged generator components, including fuel.

**Recommendation:** Consider increasing the number of backup generators, including permanent generators and trailer-mounted portable generators. Consider natural gas fired generators where natural gas service is available. Collaborate with power providers on additional resiliency measures, such as dual power feed and automatic switching capabilities.

**(3) Observation:** Power outages in water distribution systems resulted in interruptions in process communications in utilities SCADA systems. These systems provide real-time data on system status, such as water pressure, storage tank levels, pump station operational status, and equipment alarms. Without this data, utilities were unable to respond remotely to system issues and field crews had to be routed to remote facilities to report back on operational status and repair needs.

**Recommendation:** Consider backup power and/or secured cellular service for SCADA communications systems.

**(4) Observation:** Unsafe Road conditions impeded the ability of chemical suppliers to deliver chemicals to treatment plants while utilities were attempting to increase water production to meet very high-water demand.

**Recommendation:** Consider increasing chemical storage on-site at treatment plants. Develop standard operating procedures for reducing chemical usage in emergency conditions while maintaining water quality.

**(5) Observation:** In areas where consumers lost power and access to water, they needed to find other water sources. Bottled water supplies in the stores were depleted within 24-48 hours. Cities set up water stations and emergency operations centers delivered pallets of water to staging areas for their communities. The winter storm underscored the importance of being prepared with supplies during emergencies. Being prepared means having one's own food, water, and other supplies to last for at least 72 hours.

**Recommendation:** Provide targeted public education. Educate the public on the need for maintaining a disaster supplies kit, including basic items a household may need in the event of an emergency. Utilize resources such as ready.gov for information on what a person will need to survive for several days after a disaster.

**(6) Observation:** The winter storm caused numerous residential pipe freeze and breaks necessitating residents to shut off the water supply to their homes. Local utilities received an overwhelming number of calls from residents seeking assistance during a weather and water crisis. Utility staff worked around the clock to assist customers in shutting off water to their homes or businesses because of broken premise plumbing pipes.

**Recommendation:** Provide education to customers on locating and operating their premise water shutoff valves.

**(7) Observation:** During the freezing temperatures experienced in February, water utilities experienced a significant spike in the number of water main breaks. This disrupted service to customers and drained



## Water, Wastewater, and Stormwater

water storage. When pipes break, there is loss of water service to customers. This can be a total outage or a reduction in water pressure. When the water pressure in the system drops below 20 psi, a boil water notice is required by TCEQ.

Water distribution system piping is comprised of several types of materials. Utilities reported a higher occurrence of smaller diameter cast iron pipes breaking than other material types. Cast iron water mains are one of the largest classes of water utility pipe materials. It was commonly used for water mains from the 1800's until the introduction of alternative materials in the 1970's, such as ductile iron and steel (Water Research Foundation, February 2011). Many utilities conduct an annual rehabilitation effort and replace a portion of older mains, focusing on mains with a break history. Structural failures of cast iron pipes are documented, and can be due to corrosion, circumferential, and longitudinal breaks.

**Recommendation:** Water utilities should consider evaluating pipe breaks that have occurred in their distribution systems, including those experienced during Winter Storm Uri. Break data should be analyzed to determine age, pipe materials, and other causes of pipe failures. Utilities should investigate the ability to use ARRA funding to assist with the cast iron pipe replacement projects. Where indicated by the analysis, utilities should develop programs to replace cast iron pipes in the water distribution systems, prioritized based on performance data.

**(8) Observation:** Surveyed utilities had difficulty moving their staff to remote locations due to lack of all-weather vehicles, or vehicles freezing up.

**Recommendation:** Utilities should prepare for future freezing weather events. Some recommendations include:

- Ensure fuel additives are available and in use prior to freezing weather.
- Ensure vehicles are equipped with snow tires or chains in advance of freezing weather.
- Consider ordering snowplow attachments for heavy equipment.

**(9) Observation:** With loss of power, some utilities were unable to pump water into storage facilities. Treated water storage is essential to meet peak daily and emergency water demands and to maintain a uniform pressure in the distribution system. Storage and water pressure in a water system is typically accomplished using elevated storage tanks and/or standpipes, pressure tanks and/or pumps.

The Texas Commission on Environmental Quality regulates the capacity of storage, pressure tanks, and pumps for Community Water Systems on groundwater [30 TAC §290.45(1)(a)], for Community Water Systems on surface water [30 TAC §290.45(1)(b)], for Noncommunity Water Systems serving transient accommodation units [30 TAC §290.45(1)(c)], and for Noncommunity Water Systems serving other than transient accommodation units [30 TAC §290.45(1)(d)]. Requirements for Wholesale Providers and Purchased Water Systems are contained in 30 TAC §290.45 as well as alternative capacity requirements. Community water systems are required to have a total storage capacity of 200 gallons per connection, with pump, elevated storage, or pressure tank capacity to meet a normal operating pressure of 35 pounds per square inch and to maintain a minimum pressure of 20 psi during firefighting.

Of the methods to meet the total storage capacity of 200 gallons per connection, the only method to maintain pressure in the event of the loss of pumping capacity is through elevated storage. TCEQ defines elevated storage capacity in 30 TAC §290.38(25) as “that portion of water which can be stored at least 80 feet above the highest service connection in the pressure plane served by the storage tank.” The



## Water, Wastewater, and Stormwater

pressure is maintained by the elevation of the tank as well as the water level within the tank. In the event of a loss of power at pump stations that fill storage tanks or loss of treatment capacity, a system can maintain pressure and provide water through elevated storage tanks.

**Recommendation:** Top off water supply storage prior to winter storm events. Water providers must fill treated water storage tanks prior to the forecasted beginning of significant weather events. Utilities should also evaluate increasing available elevated storage.

**(10) Observation:** During the freezing weather, some utilities reported difficulties accessing their facilities due to loss of electricity powering automated gates. Utilities also reported staff safety concerns related to accessing treatment plants and pumping and storage facilities in frozen and icy conditions. Staff also required support in the form of cots, bedding, winter weather gear, and meals-ready-to-eat (MREs).

Automated gates are used for convenience and security for accessing secured water facility sites. Some of these sites are remoted and unmanned. When power is lost, these gates can no longer function in an automated manner. Security of water supply facilities is paramount to the safety of our drinking water. As such the TCEQ regulates security measures including intruder resistant fence in numerous locations in 30 TAC §290. During inclement weather such snow, ice, or extreme winds vehicle gates can be difficult to open due to ice and snow buildup, blocked by downed trees or poles or pressure against the gate from strong winds. In an emergency, precious time can be lost entering a facility through the intruder resistance fence in a vehicle if the large gates need to be cleared prior to being opened. Vehicle gates may also be controlled with electric gate openers, in the event of a loss of electricity, the gate openers will not be operational again delaying or preventing the entrance to the secured facility. Manway gates may suffer from the same ice and snow buildup and blockages, however a manway gate that swings both ways may be cleared faster allowing quicker access to a secured facility.

**Recommendation:** There are many activities that utilities need to prepare for winter weather, such as pipe insulation, draining non-critical piping, storing strap-on boot spikes, bedding, and MREs. Additionally, utilities should ensure manual access to critical facilities, such as a secure manway or walk-through gate through an intruder resistance fence. This access must meet the requirements of 30 TAC §290.31(41) and 30 TAC §290.41 and include staff training on how to manually disengage the gate and operate the gate in freezing weather.

**(11) Observation:** In systems that utilized automated meter reading, utilities were able identify unusual water usage by customers, thus assisting with identifying where premise plumbing breaks had occurred. This was especially helpful where there were unoccupied buildings.

AMI is an integrated system of smart meters, communications networks, and data management systems that enables two-way communication between utilities and customers (U.S. Department of Energy, Office of Electric Delivery and Energy Reliability, September 2016). The system provides several important functions that are either not possible in analog metering systems or must be performed manually, such as the ability to automatically and remotely measure water use and combine with customer technologies, such as computer and mobile phone apps. Some AMI systems provide the additional benefit of allowing remote to connect and disconnect service.

There are many benefits of AMI ranging across meter operations, customer service, water system operations and water resource sustainability (Downs, K., April 28, 2020). The implementation of AMI



## Water, Wastewater, and Stormwater

meters throughout a water system reduces the time needed to collect meter information by collecting the information electronically and reduces errors, improving the accuracy of meter readings. Reducing the number of workers in the field reading meters also reduces work-related injuries. Integrating AMI into the internal and public-facing processes of the utility improves the resolution of customers' inquiries and empowers customers to understand their water bills and adjust their water usage accordingly. AMI meters complement other water efficiency and conservation initiatives.

During the winter storm Uri in February 2021, with the combination of freezing temperatures and loss of power, many residents suffered broken water lines within their homes and businesses. Approximately 31% of Texas received water damage to their residence (Watson, K. et al., 2021). AMI systems could have helped minimize property damage by detecting system anomalies and alerting customers and routing crews more quickly and efficiently to shut off water services.

**Recommendation:** Include emergency response to the list of benefits when justifying Automated Metering Infrastructure (AMI) implementation.

### Legislative Action after the Storm

The Texas Legislature meets every odd numbered year. Winter storms Uri and Viola occurred approximately one month after the legislative session began. The Texas Legislature took immediate action and crafted Senate Bill 3 that provides for the preparation for, prevention of, and response to extreme weather emergencies and extended power outages. The new law creates Section 13.1394 of the Texas Water Code, which expands the definition of an "affected utility," to include every water utility in Texas. Senate Bill 3 requires all drinking water and raw water utilities to submit an emergency preparedness plan to TCEQ with options to demonstrate that the utility can maintain 20 psi water pressure during a power outage lasting 24 hours or more, as soon as safe, and practicable following the occurrence of a natural disaster.

By November 1, 2021, water utilities must submit information to the Public Utility Commission of Texas (PUC) identifying each electric utility that provides transmission and distribution service to the affected utility, each retail electric provider that sells electric power to the affected utility, and contact information for the office of emergency management of each county in which the utility has water and wastewater facilities that qualify for critical load status under rules adopted by the PUC and the division of emergency management of the governor.

The Emergency Preparedness Plan is required to be submitted to the TCEQ by March 1, 2022. Senate Bill 3 also added special billing provisions for water outages due to extreme cold weather events, (10°F for 24 hours), requiring water utilities to waive late fees, include payment plans and prohibits suspension of service disconnections due to nonpayment; and allows TWDB to provide grants to weatherize water and wastewater systems.



## Conclusion

In conclusion, the cascading events of the unexpectedly prolonged power outages during the Winter storm in February 2021 tested many water utilities. Based on this committee’s survey of utilities, the main disruptions were in potable water delivery to customers. Power disruptions and extended outages caused system communication disruptions and pumping disruptions. The lack of power in businesses and homes caused temperatures to reach freezing which resulted in broken premise plumbing. The water demands caused by these broken pipes stressed water utility treatment facilities which were in reduced capacity mode due to winter maintenance activities.

The authors of this report have provided information on cascading events and root causes of system failures. The recommendations in this report may be obvious to utilities that were operationally challenged during Winter Storm Uri and in the following months. However, it is important to stay vigilant in recalling and taking action to make improvements to avoid a repeat of the cascading events that occurred in February.

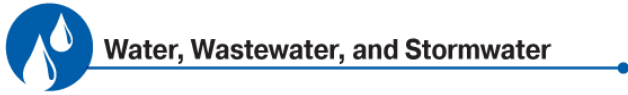

## Appendix A - Root Cause Analysis Diagrams

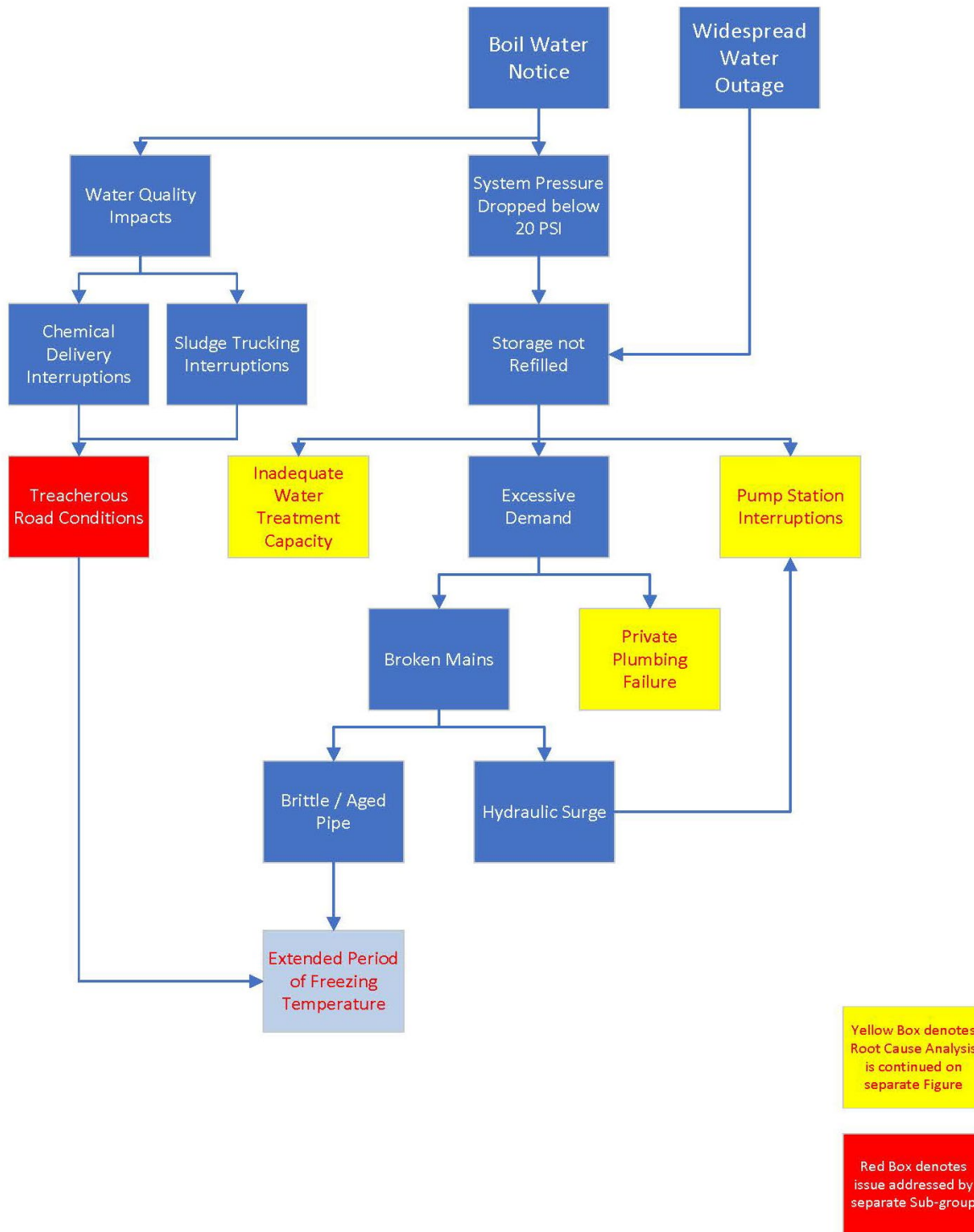
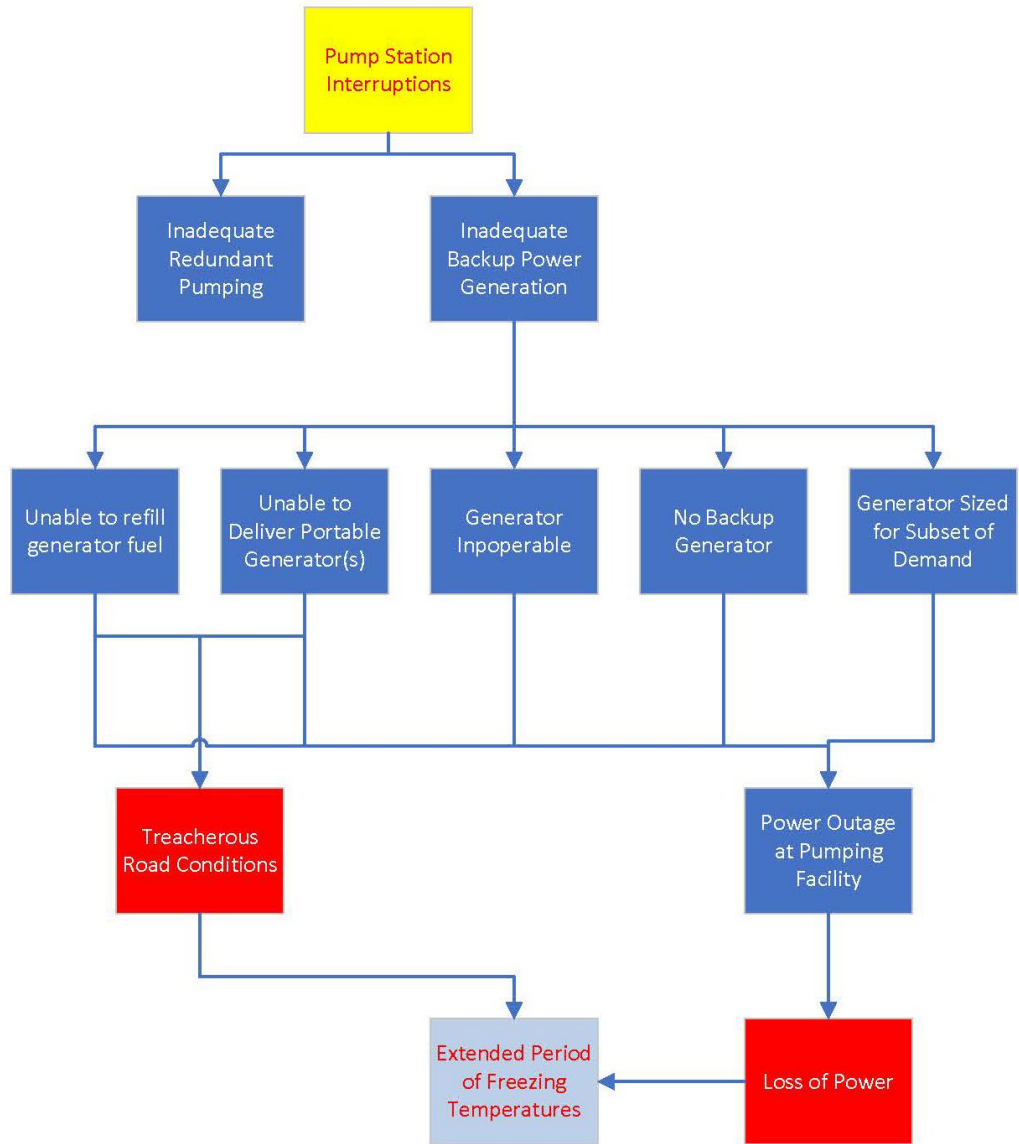

Figure 7 Root Cause Analysis





**Figure 8 Root Cause Analysis - Continuation of Pump Station Interruptions**

 **Water, Wastewater, and Stormwater**

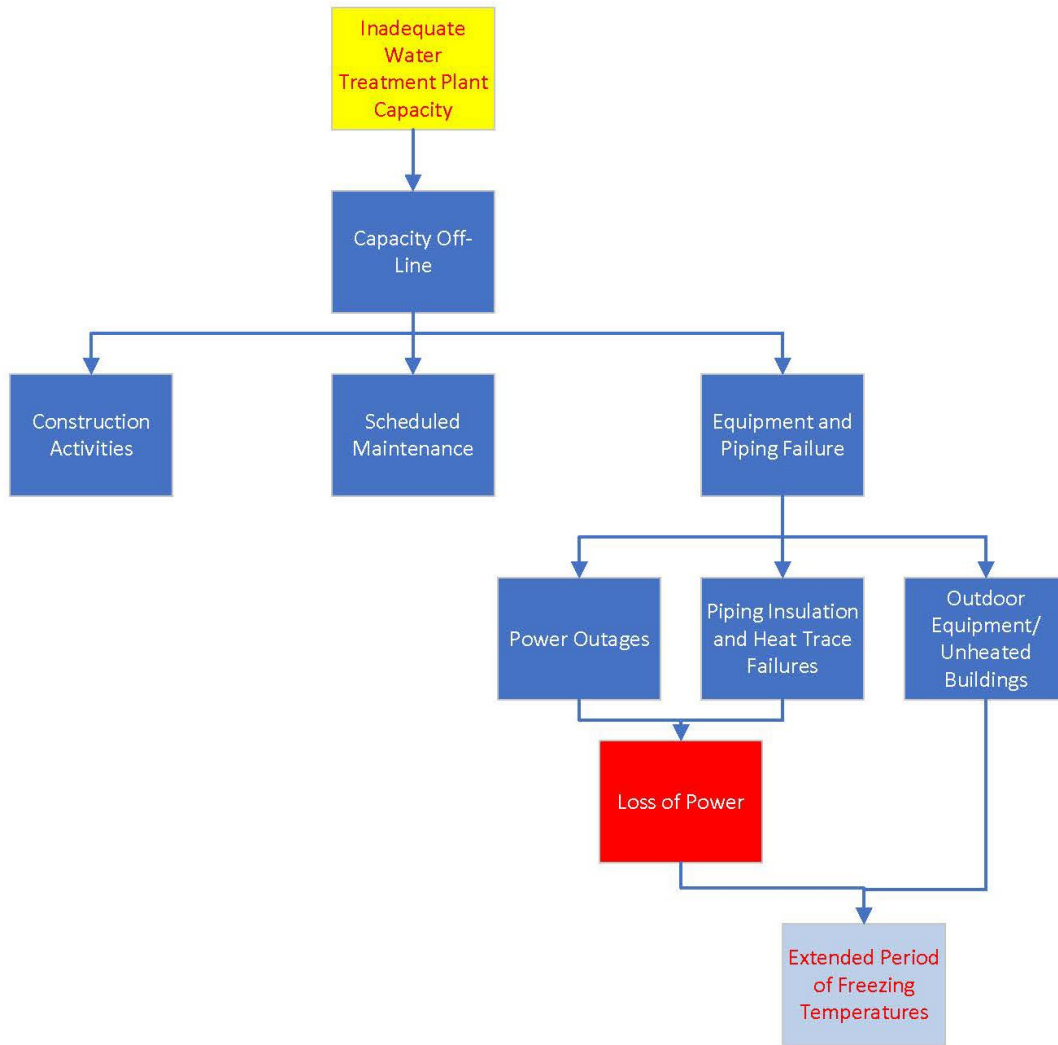

**Figure 9 Root Cause Analysis - Continuation of Inadequate Water Treatment Plant Capacity**

 **Water, Wastewater, and Stormwater**

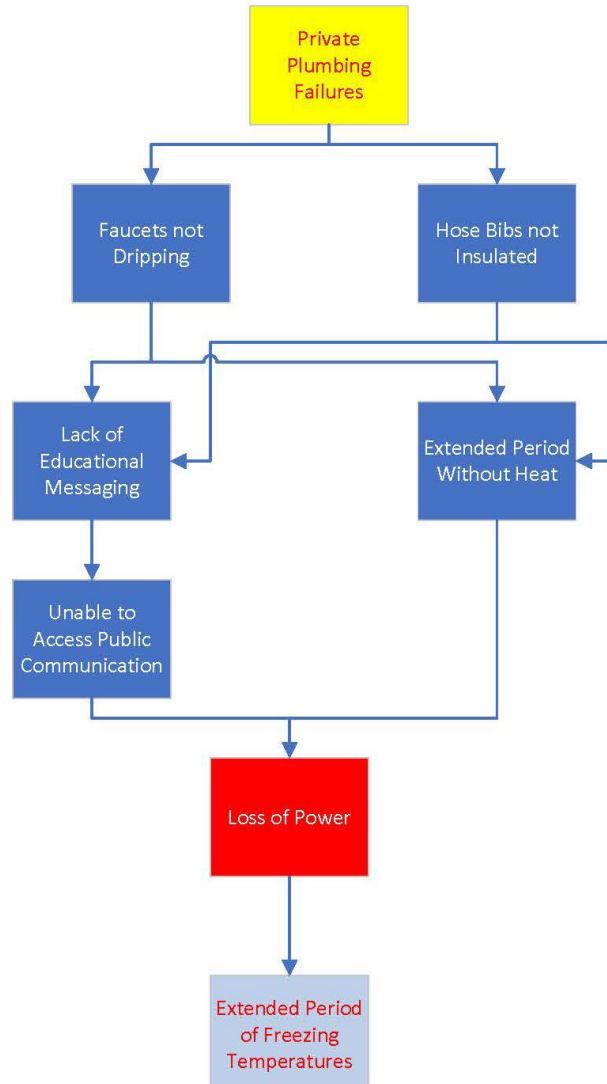

**Figure 10 Root Cause Analysis - Continuation of Private Plumbing Failures**



## Water, Wastewater, and Stormwater

### References

- American Geosciences Institute, *What is surface water and what affects its availability?*, retrieved from url: <https://www.americangeosciences.org/critical-issues/faq/what-is-surface-water-and-what-affects-its-availability>
- American Society of Civil Engineers, *Infrastructure Report Card on Drinking Water*, 2021, retrieved from url: <https://infrastructurereportcard.org/cat-item/drinking-water>
- American Water Works Association, *Policy Statement on Electric Power Reliability for Public Water Supply and Wastewater Utilities*, 28 October 2019, retrieved from url: <https://www.awwa.org/Policy-Advocacy/AWWA-Policy-Statements/Electric-Power-Reliability-for-Public-Water-Supply-and-Wastewater-Utilities>
- Centers for Disease Control and Prevention, *Public Water Systems*, page last reviewed: March 30, 2021, retrieved from url: <https://www.cdc.gov/healthywater/drinking/public/index.html>.
- City of Austin, *Austin City Council approves \$10 million in Utility Bill Relief and other measures to help those dealing with winter storm*, March 04, 2021, retrieved from url: <https://www.austintexas.gov/news/austin-city-council-approves-10-million-utility-bill-relief-and-other-measures-help-those-dealing-winter-storm>
- Dallas Fort Worth Community Impact, *City of McKinney authorizes disaster relief measures*, March 03 2021, retrieved from url: <https://communityimpact.com/dallas-fort-worth/mckinney/government/2021/03/03/city-of-mckinney-authorizes-disaster-relief-measures/>
- Downs, K., April, *Internet of Water, Unearthing the Hidden Benefits of Advanced Metering Infrastructure (AMI)*, 28, 2020
- FEMA, (2021) *Texas Severe Winter Storm*, 2021, retrieved from url: <https://www.fema.gov/disaster/3554>
- Gay et. Al, (2018). *AWWA Manual M19, Emergency Planning for Water Utilities*, Washington D.C., American Water Works Association, 2018.
- Gay, Stephen D., and Scott D. Borman, *M19 Emergency Planning for Water Utilities*, / by Stephen D. Gay and Scott D. Borman. Fifth edition, Denver, Colorado: American Water Works Association, 2018. Print.
- Public Utility Commission of Texas, *Water Utility Information*, retrieved from url: <https://www.puc.texas.gov/watersearch>
- Spencer Grubbs, Shannon Halbrook, Jessica Donald and Bruce Wright, *Texas Water: Planning for More, Fiscal Note*, April 2019, retrieved from url: <https://comptroller.texas.gov/economy/fiscal-notes/2019/apr/tx-water-planning.php>
- Texas Commission of Environmental Quality, *After-Action Review of Public Water Systems and Winter Storm Uri*, November 18<sup>th</sup>, 2021, retrieved from url: <https://www.tceq.texas.gov/drinkingwater/after-action-review>
- Texas Commission on Environmental Quality (TCEQ), Office of Water, Water Supply Division, *State of Texas Public Drinking Water Program 2019 Annual Compliance Report*, July 1, 2020
- Texas Commission on Environmental Quality (TCEQ), retrieved from url: [https://www.tceq.texas.gov/assets/public/permitting/water-supply/pdw/EPA\\_ACR\\_2019\\_final.pdf](https://www.tceq.texas.gov/assets/public/permitting/water-supply/pdw/EPA_ACR_2019_final.pdf)
- Texas Commission on Environmental Quality (TCEQ), *Wastewater Outfall Viewer*, <https://tceq.maps.arcgis.com/apps/webappviewer/index.html?id=d47b9419f42c49dea592203aeda99da1>, Retrieved May 20, 2021
- Texas Commission on Environmental Quality, *Homeland Security for PWS: Disaster and Recovery*, retrieved from url: [https://www.tceq.texas.gov/drinkingwater/homeland\\_security](https://www.tceq.texas.gov/drinkingwater/homeland_security)
- Texas Commission on Environmental Quality, *Public Notice Language for Drinking Water Compliance*, 2021, retrieved from url: [https://www.tceq.texas.gov/drinkingwater/public\\_notice.html](https://www.tceq.texas.gov/drinkingwater/public_notice.html)
- Texas Commission on Environmental Quality, *Subchapter D: Rules and Regulations for Public Water Systems, Austin, Texas*, 2019, retrieved from url: <https://www.tceq.texas.gov/assets/public/legal/rules/rules/pdflib/290d.pdf>
- Texas Section of the American Society of Civil Engineers (ASCE) 2021 Texas Infrastructure Report Card, 2021
- Texas Water Development Board, *2022 Texas State Water Plan*, 2021, retrieved from url: <https://www.twdb.texas.gov/waterplanning/swp/>
- Texas Water Development Board, *Historical Water Use Estimates*, 2018, retrieved from url: <https://www.twdb.texas.gov/waterplanning/waterusesurvey/estimates/>
- Texas Water Development Board, *Interactive 2022 State Water Plan Website*, 2021, retrieved from url: <https://texasstatewaterplan.org/statewide>
- Texas Water Development Board, *State Water Plan*, 2021, retrieved from url: <https://texasstatewaterplan.org/statewide>
- Texas Water Foundation, *Texas Water Systems Map*, 2021, retrieved from url: <https://www.texaswater.org/texas-water-systems-map>



## Water, Wastewater, and Stormwater

The Washington Post, *Power returns for many in Texas, but water crisis escalates as storm damage spreads*, February 02, 2018, retrieved from url:

[https://www.washingtonpost.com/national/texas-drinking-water-winter-storm/2021/02/18/95c898dc-7222-11eb-a4eb-44012a612cf9\\_story.html](https://www.washingtonpost.com/national/texas-drinking-water-winter-storm/2021/02/18/95c898dc-7222-11eb-a4eb-44012a612cf9_story.html)

U. S. Department of Energy, *The Water- Energy Nexus: Challenges and Opportunities Overview and Summary*, 2014

U.S. Department of Energy, Office of Electric Delivery and Energy Reliability, *Advanced Metering Infrastructure and Customer Systems: Results from the Smart Grid Investment Grant Program*, September 2016

United States Geological Survey, *Water*, retrieved from url: <https://www.usgs.gov/products/data-and-tools/data-and-tools-topics/water>.

University of Michigan Center for Sustainable Systems, U.S. Water Supply and Distribution Factsheets, September 2021, retrieved from url: <http://css.umich.edu/factsheets/us-water-supply-and-distribution-factsheet>

Water Research Foundation and National Research Flagships, DSIRO, “Practical Tool for Deciding Rehabilitation Techniques for Cast Iron Pipes-Literature Review” by David Beale, Dung Tran, Scott Gould Brad Lane & David Marlow, *Water for a Healthy Country Flagship Report*, February 2011

Watson, K., Cross, R., Jones, P., Hobby School of Public Affairs, University of Houston (<https://uh.edu/hobby/winter2021/storm.pdf>), *The Winter Storm of 2021*, 2021.

Wikipedia, *February 13–17, 2021 North American winter storm*, retrieved from url: [https://en.wikipedia.org/wiki/February\\_13%E2%80%9317,\\_2021\\_North\\_American\\_winter\\_storm](https://en.wikipedia.org/wiki/February_13%E2%80%9317,_2021_North_American_winter_storm)

# Electricity Infrastructure

## The Electricity Network

The electricity infrastructure network, or “the grid” as it is commonly referred to, consists of four primary components that must operate in perfect harmony. The infrastructure components of the electrical power grid network are generally considered to be: 1) Generation, 2) Transmission, 3) Distribution, and 4) Substations, including control systems which serve to connect each of the above primary system components and modify (step up or step down the voltages) for the next step in electricity’s journey to the end user.

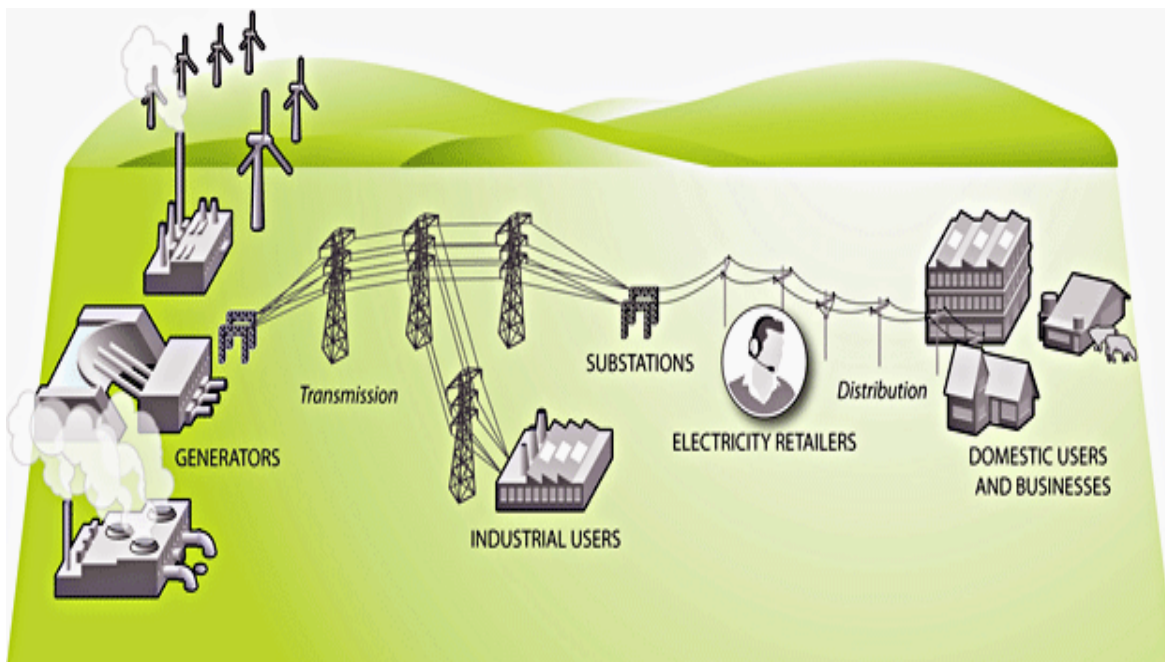

Figure 1: Schematic of the Electricity Grid (ASCE)

Under deregulation of electric power in Texas, generation of electricity has been decoupled from transmission, distribution, and substations. The overall grid itself is managed by the Electric Reliability Council of Texas (ERCOT), under regulatory oversight of the Public Utility Commission of Texas. Generation and retail marketing of electricity are provided by firms not economically regulated in Texas. Firms that provide electricity generation are no longer able to operate transmission and distribution facilities (these components of the power grid are still operated and maintained by regulated utility entities). The exceptions to this are Municipal Utilities and Electric Cooperatives. Texans choose to purchase electricity from among dozens of retail electric providers (REPs), electric power retailers and/or incumbent distribution utilities, that all operate competitively to buy and sell electrical power in an open market.



### ***ERCOT's role in the system***

According to the U.S. Energy Information Administration, “Texas both produces and consumes more electricity than any other state, generating almost twice as much as the second-highest electricity-producing state, Florida”<sup>i</sup>. Texas has abundant natural resources, including natural gas, coal, and wind to fuel power plants. The Electric Reliability Council of Texas (ERCOT) serves as an Independent System Operator (ISO) for the Texas Interconnection which is one of three main electrical grids in the U.S. The other two are the Eastern Interconnection, and the Western Interconnection. ERCOT thus manages the flow of electrical power to approximately 26 million customers in the state of Texas, representing approximately 90% of Texas’ electrical load<sup>ii</sup> in 213 of the 254 counties in Texas. The counties near the state’s borders are provided electricity by the Eastern and Western grids.

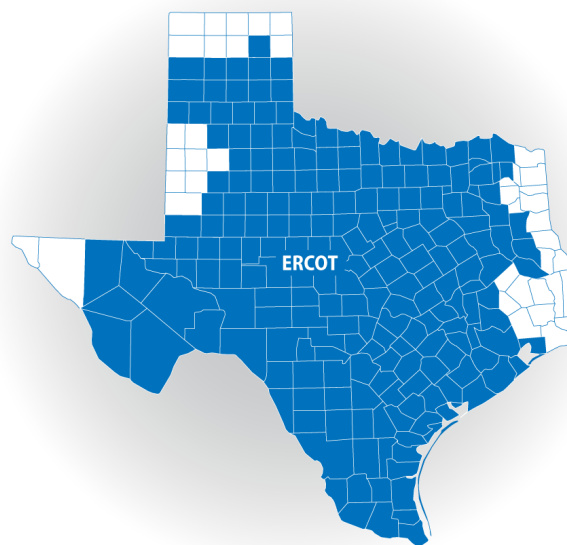

Figure 2: ERCOT Service Area

ERCOT’s primary responsibilities are managing the expansion and reliability of the power grid (comprised of 46,500+ miles of high-voltage transmission lines and 710+ generating units, excluding Private Use Networks), ensuring open access to transmission lines, facilitating a competitive wholesale market, and facilitating a competitive retail market.<sup>iii</sup>

The components (transformers, wires, poles, and towers, etc.) of this complex network have remained substantially unchanged over the last several decades. However, the diversity of fuel sources that feed into the Generation of electrical power has undergone significant change both nationwide, and in Texas in the last decade. The amount of generation from coal fired power plants has continue to be displaced by generation from natural gas fueled power plants, and from renewable energy sources such as wind and solar power facilities. Current installed capacity of power facilities by fuel source is shown in the figure below.



## Electric Generation, Transmission & Distribution Overview

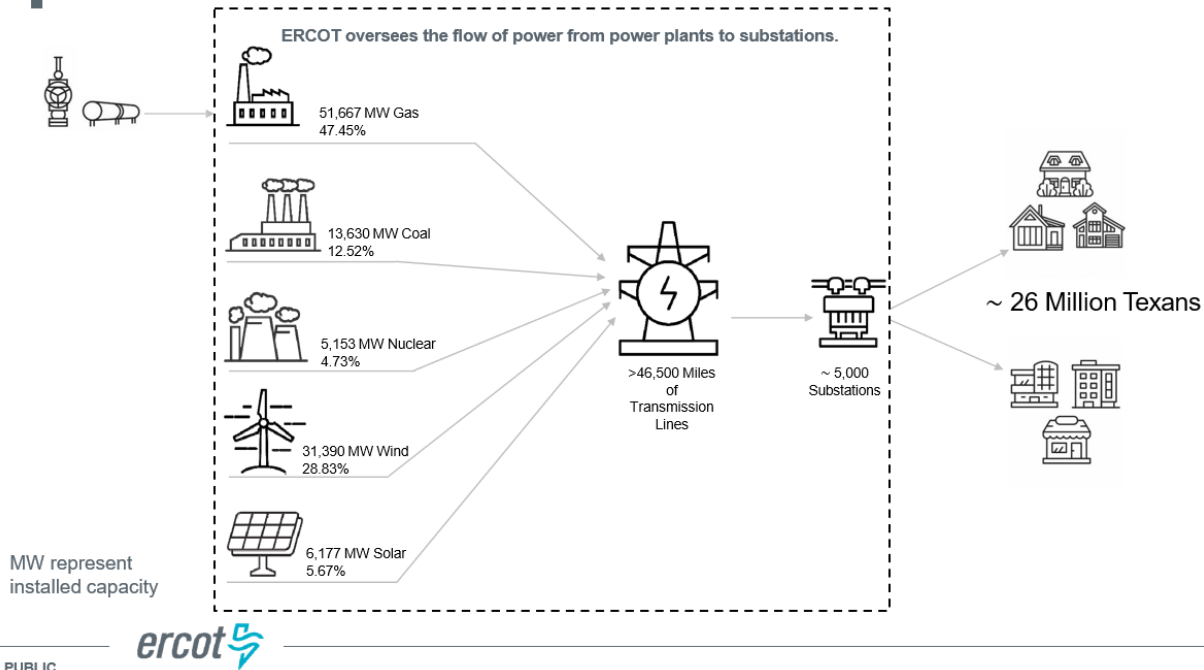

Figure 3: From ERCOT Presentation "Review of February 2021 Extreme Cold Weather Event" February 24, 2021

ERCOT is a non-profit organization, governed by a board of directors, and subject to oversight from the Public Utility Commission of Texas and the Texas legislature. Its members (owners) include consumers, cooperatives, power marketers, retail electric providers, investor-owned electric utilities (transmission and distribution providers) and municipal-owned electric utilities.

Operating as an energy-only market with real-time, day-ahead, and ancillary service markets, ERCOT also performs financial settlement for the competitive wholesale bulk- power market and administers retail switching for seven million premises in competitive choice areas. In addition to the ERCOT administered energy markets, many market participants transact on a bilateral contract basis. The Supply (generators) and Load Serving Entities (demand or load) may exchange electricity or rights to generating capacity under mutually agreed terms for a specific period through these bilateral arrangements. These parties would typically enter these transactions ahead of the ERCOT administered market to avoid potential shorter-term price volatility.

The natural gas market is built upon thousands of bilateral commodity transactions, some managed through digital platforms, combined with transportation and related services managed through electronic bulletin boards (EBBs). ERCOT has no role in the performance or operation of the natural gas markets.

The electricity industry, under deregulation in Texas, has been functionally separated, with only the transmission and distribution providers remaining as traditionally

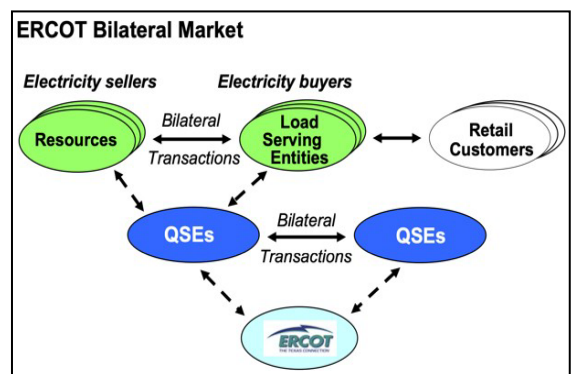

Figure 4





## Electricity Infrastructure

regulated utilities. These entities may no longer own generation or supply electricity directly to customers. Generation and customer supply functions are now performed by entities whose prices charged are subjected only to competitive forces and are not set as regulated rates.

### Generation of Electricity

The production of electricity begins at the generation facility, or power plant. On an operational basis, there are two primary types of generation: dispatchable (power plants that can turn on and off based upon the need of the system) and non-dispatchable (power plants that turn on and off based upon their source of energy/fuel input). Generally, non-dispatchable generation is located where its energy resource (solar, wind, hydroelectric) is the richest. During the past 20 years, the location of new renewable generation capacity has reflected this trend.

Dispatchable plants tend to locate closer to load centers. The location of new dispatchable plants in Texas have largely been developed in and around major load centers. A natural gas fired plant would be considered a dispatchable power plant, while a solar plant would be considered a non-dispatchable plant. Each power plant usually is composed of several individual generator units. Each dispatchable generator unit has its own unique start-up/response criteria and ramp rates up /down for increasing and decreasing output. ERCOT has more than 710 different generators located across its transmission system and dynamically oversees the output, ramp rates and availabilities of each of these resources against the needs of the system and changing demand.

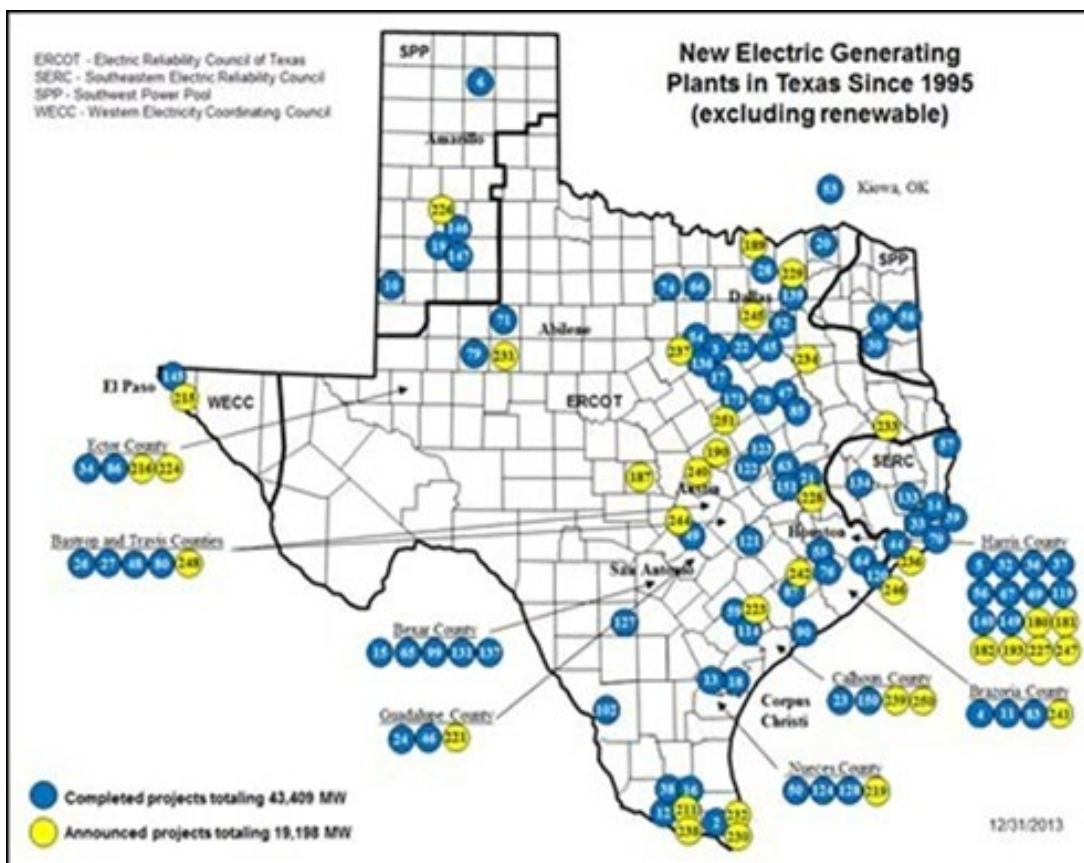

Figure 5



**Transmission of Electricity – High Voltage**

At the tailgate of an operating power plant, electricity voltage is stepped up (increased) by transformers to high voltage for transmission to the market or demand centers. More than 46,500 miles of high voltage transmission lines in ERCOT are akin to a highway system for electricity. These high voltage lines allow for larger volumes of power to move around the system over longer distances.

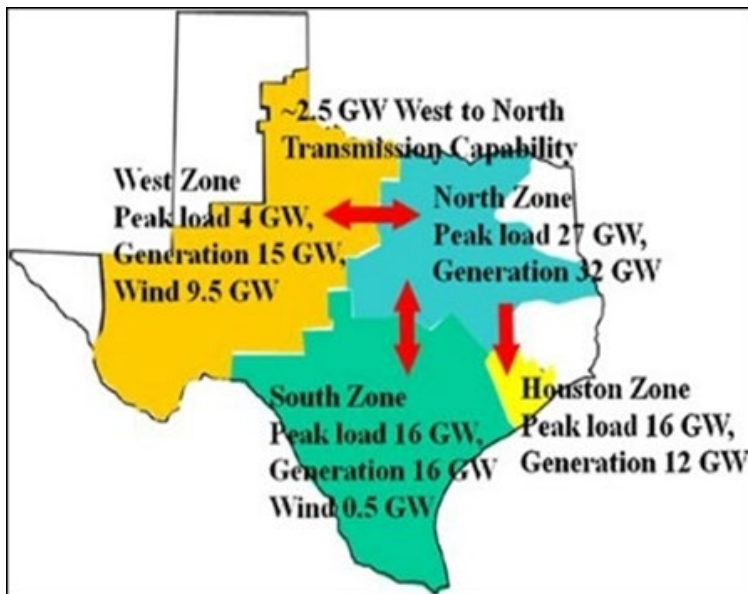

Figure 6

One difference between moving electricity through wires compared to moving vehicles on our highways is that an electrical current constantly seeks the path of least resistance between the source of electricity generation and the demand (load) for electrical power. When this happens unexpectedly, the load flowing across a transmission line can exceed the transmission line’s operating parameters, overloading the capacity of a given segment of the transmission system. In addition, physical failure due to extreme weather events beyond the structural design parameters of the line, or damage caused by falling trees, can interrupt, or trip offline a critical transmission line pathway. The actions taken by ERCOT to ensure transmission flows do not exceed the equipment capability can result in congestion. Too much congestion, or a line trip due to a failure can make the system unstable. To avoid congestion, the system operator may require a change in which power plants are dispatched to different power plants to relieve. That out of merit (economic) dispatching increases the cost to the consumer but is necessary to ensure reliable service.

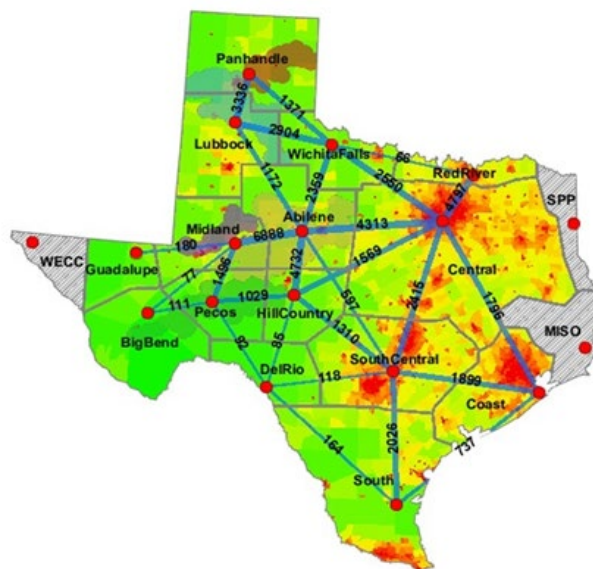

Figure 7

**Distribution of Electricity – Low Voltage**

The transmission system described above delivers



## Electricity Infrastructure

electricity to the electrical distribution system where it is stepped down in voltage, and as the name implies, distributed to the doorsteps of end users to serve their demand, or need. Electricity retailers then market and transact this delivered power to the end users. Forced customer curtailments is managed at the distribution level.

Residential electricity usage for cooling and heating is a big driver of overall system demand. Electricity demand during the summer very closely tracks temperature and air conditioning use.

Winter demand is much more variable because of variable temperatures. 60% of Texas households rely on electric heat. Much of this (especially new construction) is provided by air-to-air heat pumps. These systems are effective and efficient until outside ambient temperatures drop to freezing. Under those conditions, supplemental heating is required and is typically provided via simple resistance heating (The same technology used in toasters). This type of heating requires large amount of electricity, resulting in very high, short duration peak demands for electricity.

### ***Grid Management Complexity***

The complexity of managing the electrical grid comes from the requirement for the system to be in balance constantly throughout the day with electricity generation matching electricity demand, all the while minimizing variations of voltage frequency across the grid due to congestion or other power flow interruptions. These are other operational complexities.

Dispatchable generators are usually controlled directly or indirectly by the grid when dispatched, adjusting up and down within certain limits throughout the day. When the system is out of balance either the supply must be increased (more generation) or the demand must be decreased. If the supply capability is exhausted or otherwise incapable of responding, the system is forced to reduce demand. To avoid catastrophic failure the motors and electrical controls on the system, these adjustments must happen immediately (within a minutes) to add or shed load needed to increase or curtail demand to maintain system balance.

Additional complexities are created from managing the constantly changing output of dispatchable and non-dispatchable generation against a market demand. Demand Side Management, which is the equivalent to dispatchable load that can be reduced to balance the system. Reconciling natural gas dispatch with real time power dispatch requirements. Other factors, such as emission limits, production variability, peak load periods<sup>2</sup>, are examples of further complexities in the power market<sup>3</sup>.

### ***The catastrophic impact of Winter Storms Uri on Texas's energy system.***

Beginning as early as Thursday, February 11<sup>th</sup>, 2021, a major arctic winter storm bringing frigid temperatures well below freezing, began to envelop the State of Texas. By Monday, February 15<sup>th</sup>, the entire State of Texas was recording sub-freezing temperatures. "For the first time in history, all 254 counties in Texas were under a winter storm warning at the same time."<sup>iv</sup> The temperatures in many parts of Texas dipped to the coldest temperatures ever in more than last 70 years.

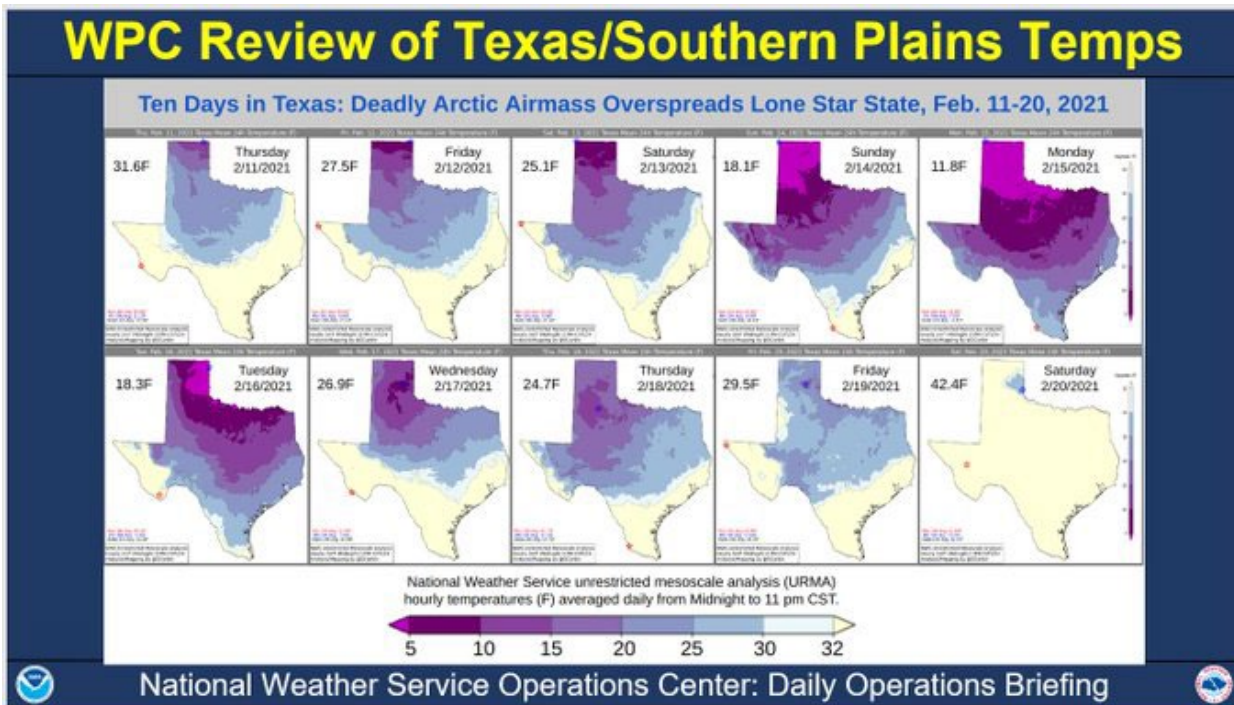
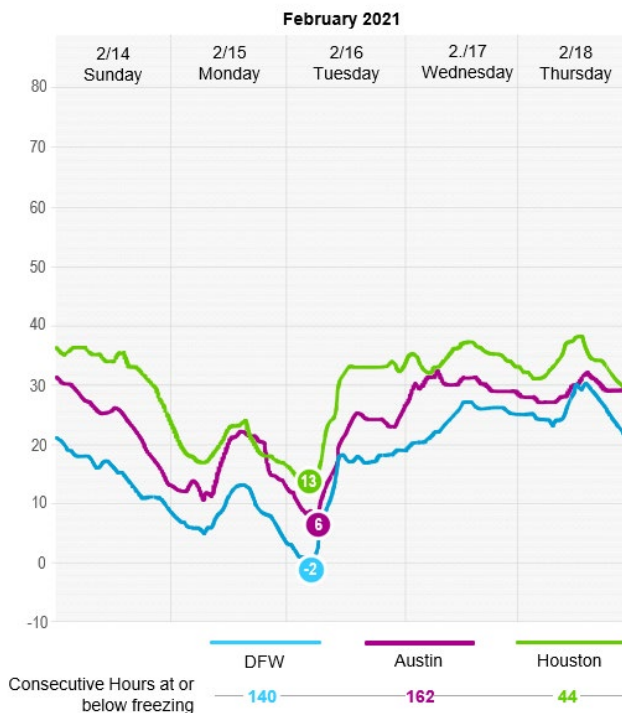

Figure 7: Source: National Weather Service Weather Prediction Center,

As the figure above shows, the winter storm event, now known as Winter Storm Uri, was extreme, widespread, and remained that way for days. The cold weather event was made even more historic by the simultaneous addition of snow and freezing rain which made travel treacherous, if not impossible in certain locations across the state not accustomed to such conditions.

With relatively mild actual temperatures across the State in December and January, despite the warnings by ERCOT’s own Meteorologist<sup>v</sup> as well as others, it was said of this event, “The cold was simply worse than almost anyone in Texas was prepared for.”<sup>vi</sup> “Based on the meteorological data, the winter storm that occurred in February was approximately a one-in-100 event.”<sup>vii</sup> As the figure below indicates, many of the major populations areas across Texas remained at or below freezing for days.

The Texas Department of Health and Human Services identified that winter storm Uri, led to the deaths of more than 210 Texans. Other estimates are much higher. In addition to the tragic loss of life, winter storm Uri had an unprecedented economic impact on the State of Texas. Touching every corner of the State, all industries were impacted, and supply chains disrupted.<sup>viii</sup> Winter storm Uri’s impacts on electrical power generation, natural gas systems, water systems, and transportation infrastructure were overwhelming.





### **Before**

Despite an ERCOT, pre-event communication made in early November to market participants and the public noting a “very good” chance for an extreme cold weather event during the winter of 2020/2021<sup>ix</sup>, ERCOT’s Winter 2020/2021 Seasonal Assessment of Resource Adequacy (SARA) “anticipated there would be sufficient installed generating capacity available to serve system-wide forecasted peak demand”.<sup>x</sup> As the winter storm event unfolded and the resulting significant deviation from historical low temperature forecasted weather data, this assessment unfortunately proved to provide an inadequate warning of the events to come.

In the days leading up to the winter storm Uri event, several pre-event operational preparations had been made by ERCOT<sup>xi</sup>, including:

- Cancelled transmission outages affecting over 1,600 transmission devices and delayed other outages.
- Reviewed planned generation outages for potential early return to service.
- Began using maximum icing potential for wind forecasts.
- Began regular calls with Chief Systems Operators (18 over 8 days).
- Waived COVID restriction and brought additional support staff on-site.
- Prepared facilities for extended on-site staffing, activated additional remote engineering/support staff.
- Supported Railroad Commission of Texas review of natural gas priority.
- Requested TCEQ/DOE enforcement discretion for power plant emission during anticipated event.

These preparations, while critically important, could not prevent what was to come.

### **During**

Once winter storm Uri began to unleash its full force upon the State of Texas, almost half of ERCOT’s gas, coal, and nuclear power generating facilities failed to produce needed electrical power when it was most needed.<sup>xii</sup> ERCOT’s data shows that 8% (9 GW) of the generation capacity was offline due to scheduled maintenance. Since Texas has traditionally experienced the highest demand for electrical power in the summer months, it is not uncommon for generators to schedule maintenance over the winter months. Another 21% (22 GW) of the generation capacity failed prior to 1 am on February 15, 2021, when ERCOT first initiated emergency demand curtailment measures, or load shedding. Emergency measures were in effect for more than 100 hours.<sup>xiii</sup> Ultimately, during the peak of this winter storm event, approximately 48% (51.2 GW) of the total installed generation capacity went offline. Approximately 12% (6 GW) of this outage has been preliminarily attributed to fuel limitations (primarily natural gas supply).



Electricity Infrastructure

Net Generator Outages and Derates by Cause (MW)  
February 14 – 19, 2021

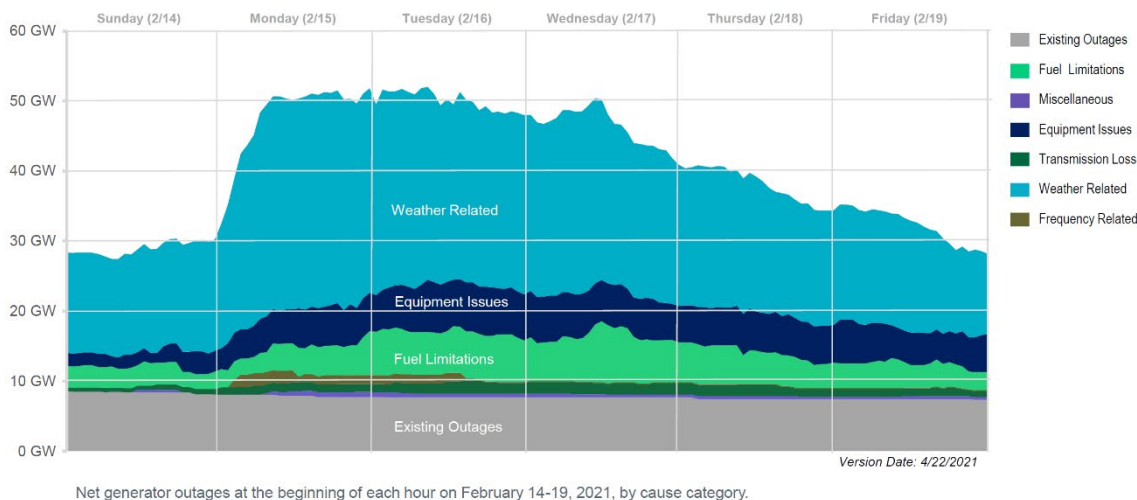

Net generator outages at the beginning of each hour on February 14-19, 2021, by cause category.



PUBLIC

4

Figure 9: ERCOT Presentation Net Generator Outages and Derates by Cause, slide 5

Simultaneous with generation capacity beginning to falter, demand for electrical power was exceeding all forecasts. Had generation outages not occurred, all-time capacity demand record (summer or winter) would likely have been reached on the ERCOT system.

Extreme Weather, Extreme Outages Pushed Texas into Blackouts

ERCOT electric load, load forecasts, thermal plant outages, and renewables

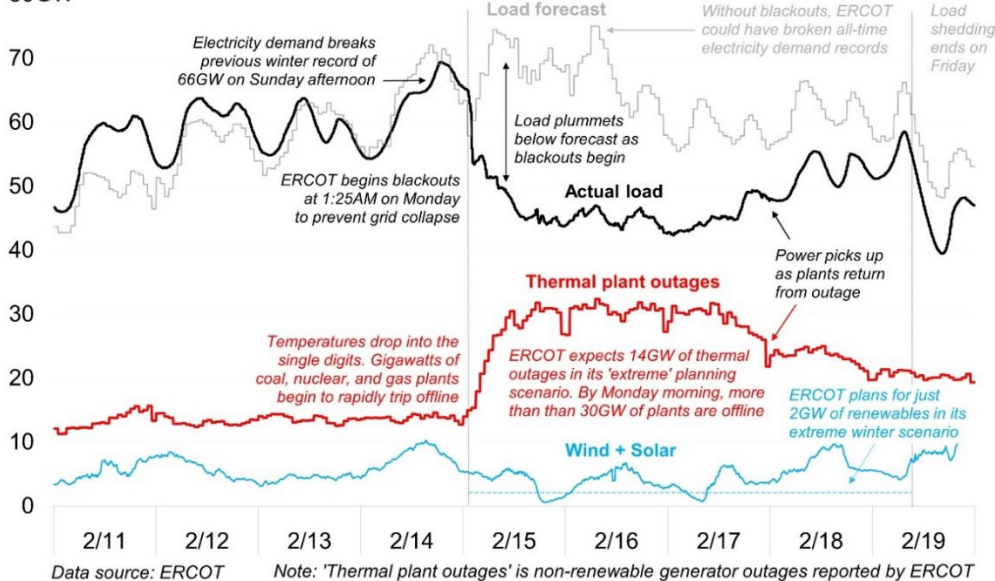

Figure 10: ERCOT Electric Load, Load Forecasts, Thermal Plant Outages, and Renewables

As is the rest of the world, Texas is becoming more “electrified”. Studies have shown that in high electrification scenarios, current installed electricity generation capacity will need to double within the next 30 years to meet this growing trend.<sup>xiv</sup> As an example, since 1980, the use of electricity as a



## Electricity Infrastructure

primary heating fuel has grown from less than 10% of Texas households to greater than 60% today.<sup>xv</sup> Much of this (especially new construction) is provided by air-to-air heat pumps. These systems are effective and efficient until outside ambient temperatures drop to freezing. Under those conditions, supplemental heating is required and is typically provided via simple resistance heating (The same technology used in toasters). This type of heating requires large amount of electricity, resulting in very high, short duration peak demands for electricity. This growing trend, combined with the unprecedented winter storm event, provide little surprise that Texas was headed for a record-breaking winter demand for electricity during winter storm Uri. That trend is not likely to change.

The long periods of time that millions of Texans were without power during the extreme cold temperatures resulted in significant property damage, including burst pipes and household flooding. “Efforts to stay warm resulted in deadly fires and exposure to carbon monoxide poisoning.”<sup>xvi</sup>

The electric power industry in Texas relies heavily on natural gas as a fuel for electric power generation. The significant natural gas producing areas around Ft. Worth and far west Texas, were among the first to experience the onslaught of freezing temperatures from this event and those same areas were significant in duration of the freezing temperatures. The Energy Information Administration reported that natural gas production in Texas fell almost 45% during the week ending February 13<sup>th</sup>.<sup>xvii</sup> The growing interdependencies between the natural gas industry and the electric power industry became critically evident as a result. The reduction in critical fuel feeding natural gas fueled generating facilities contributed to electrical power generation outages and derates, which in-turn contributed to a further requirement for ERCOT to necessitate orders for reductions in the demand for electrical power (load shedding). An analysis prepared for the Texas Oil and Gas Association<sup>xviii</sup>, if loss of electrical power to upstream operators contributed to 65% of the reduction in natural gas availability, wellhead and equipment freeze-offs contributed 13%, and third-party facilities (pipelines, gathering, transmission, processing facilities, plants) contributed to approximately 9%. Other logistical issues such as road conditions prevented operators from hauling produced water and oil and limited their ability to get crews out to the production sites to make repairs and mitigate wellhead freeze-offs.

### **Post Storm**

There is little doubt that ERCOT’s quick actions to order emergency load curtailment when it did, helped to avoid more serious damage to the sensitive electronic and generation equipment components of the power grid that were still online.<sup>xix</sup> Providing and operating a “reliable” electrical grid will also require getting better at improving resource adequacy assessments. Those efforts appear already underway with the focus and attention being given to identifying and addressing low-probability, high-impact events in the Seasonal Assessment of Resource Adequacy (SARA) reports.<sup>xx</sup>

Much discussion has taken place regarding whether the grid in Texas should become more interconnected and integrated with the Eastern and Western Interconnections. Whether that would have helped during this event is uncertain. The electrical grids all around Texas were also experiencing shortfalls of electrical power supply themselves so it is not clear how much additional electrical power would have been available, even if those interconnections were to have existed.



## Electricity Infrastructure

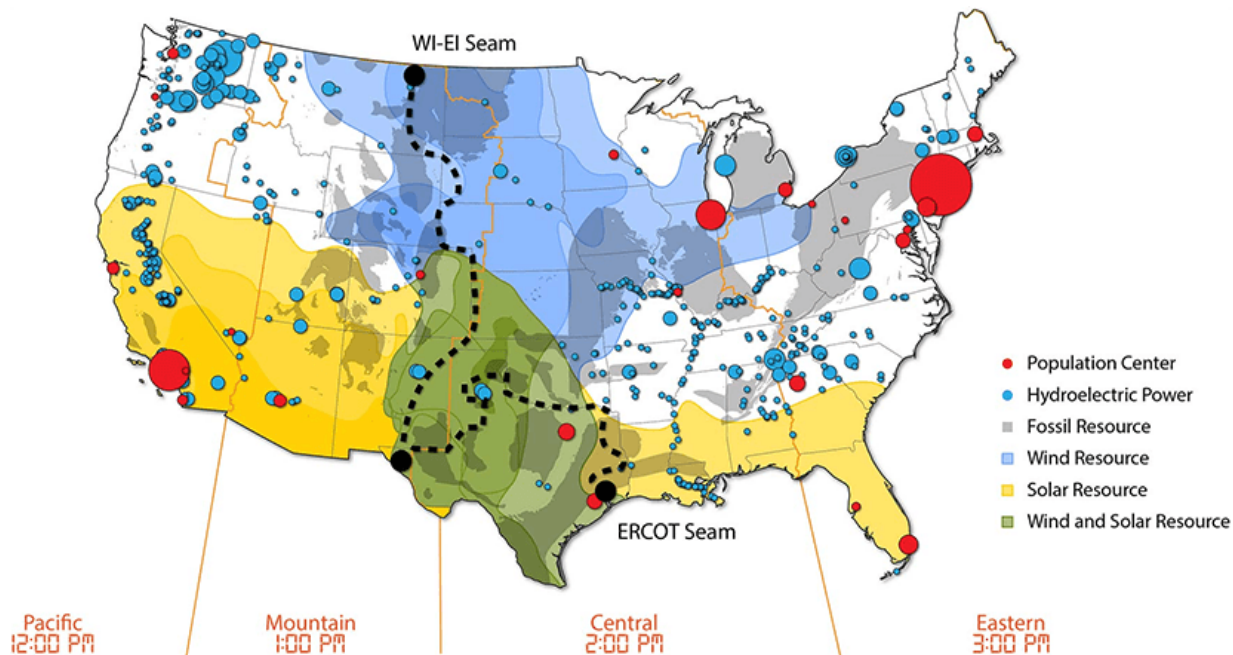

Although studies are underway, “Very little electricity is transferred between the interconnections due to limited transfer capacity.”<sup>xxi</sup>

Although it was avoided, all parties need to revisit the “Black Start” plans they have in place to ensure they will be able to implement them as needed.

### **Ranking of the impacts/problems encountered before, during, and post storm**

The “essentiality” of electrical power has been brought to the attention of all Texans because of this winter storm event. The impact on the loss of electrical power has impacted a wide variety of infrastructure including water, sewer, transportation, telecommunication, natural gas, and others. Winter Storm Uri has exposed several impacts/problems in how we think about the electrical grid in Texas. This team observed that there were several critical sector specific issues exposed during this winter storm event including:

- Ineffective generation sector market incentives to develop and implement a culture of high reliability and resiliency.
- Failure to heed prior warnings and recommendations for power generation and fuel supply infrastructure winterization was evident.
- Gaps were found in the “load shed” methodologies used by electric distribution utilities, specifically in how “load shed” quantities were allocated and managed.
- Failure to properly identify and coordinate between the natural gas and electric industry to exclude certain critical natural gas infrastructure from having electricity service curtailed.
- A limitation from limited grid interconnectivity between the Eastern, Western, and ERCOT grids greatly limited the potential for load demand sharing to better manage the high load demand resulting from this winter storm event.
- Critical weaknesses in “Black Start” generation readiness were exposed.





## Electricity Infrastructure

Winter Storm Uri has dramatically increased the calls for increased reliability and resiliency of our electrical grid. With the calls for increased resiliency, there is also an increasing realization that the electrical grid, not only in Texas but in all the USA, is amid a continuing transformation. That transformation is being brought about by changes in how and where electrical power is being generated and certainly how that electrical power is being consumed. Without question, there have been significant changes in fuel resources that are being used for generation – the increasing additions of wind, solar, and natural gas fueled power generation are leading in that change.

We are also beginning to realize that climate change may be affecting the severity of the weather events, particularly those affecting Texas (both more frequent and damaging extreme wind events, flooding events, as well as extreme cold temperature events). And finally, Regulators will need to face the tough decisions of cost versus consequence in determining electric power regulations needed to increase reliability and resiliency.

## Recommendations

Based upon these observations, the ASCE Texas Section makes the following recommendations for the electric sector:

- Properly incentivize the market, particularly in the generation component, to develop and implement a high reliability and resiliency prioritized culture that include a focus on winterization and dependable fuel supply infrastructure.
- Rationalize the current “load shed” methodologies used by the power distribution utilities to ensure effective allocation between distribution utilities and load shed execution.
- Ensure exclusion of critical interdependent natural gas infrastructure from ordered load demand response. Adopt routine market simulation exercises between the electric and natural gas industries to develop awareness of solutions to interdependent operational challenges.
- Evaluate expanding grid interconnectivity between the Eastern, Western, and the ERCOT grid for emergency load demand sharing situations reduced the potential options available to manage the high load demand resulting from this winter storm event.
- Take steps to ensure “Black Start” generation can perform with top decile performance and reliable fuel options under a wide range of adverse conditions.



## End Notes

- <sup>i</sup> U.S. Energy Information Agency, “Texas State Profile and Energy Estimates”
- <sup>ii</sup> Bill Magness, “Review of February 2021 Extreme Cold Weather Event – ERCOT Presentation,” Presentation to the ERCOT Board of Directors, February 24, 2021.
- <sup>iii</sup> ERCOT Fact Sheet March 2021
- <sup>iv</sup> Texas Power Failures: What Happened in February 2021 and What Can Be Done? (page 5)
- <sup>v</sup> ERCOT Senior Meteorologist – Weather Forecast updated February 12, 2021
- <sup>vi</sup> Texas Power Failures: What Happened in February 2021 and What Can Be Done? (page 5)
- <sup>vii</sup> ERCOT News Release May 06, 2021: Record electric demand expected this summer
- <sup>viii</sup> The Perryman Group Preliminary Estimates of Economic Costs of the February 2021 Texas Winter Storm
- <sup>ix</sup> Bill Magness, “Review of February 2021 Extreme Cold Weather Event – ERCOT Presentation”
- <sup>x</sup> ERCOT’s Winter 2020/2021 Seasonal Assessment of Resource Adequacy (SARA)
- <sup>xi</sup> Bill Magness, “Review of February 2021 Extreme Cold Weather Event – ERCOT Presentation”
- <sup>xii</sup> ERCOT’s data included in presentations to the Texas House and Senate Committees on February 25, 2021 and the Update to April 6, 2021 Preliminary Report of Causes of Generator Outages and Derates During the February 2021 Extreme Cold Weather Event (April 27, 2021)
- <sup>xiii</sup> Bill Magness, “Review of February 2021 Extreme Cold Weather Event – ERCOT Presentation”
- <sup>xiv</sup> NREL, Electrification Futures Study: Scenarios of Power System Evolution and Infrastructure Development for the United States.
- <sup>xv</sup> Davis, Lucas. “The Texas Power Crisis, New Home Construction, and Electric Heating” Energy Institute Blog, UC Berkeley, February 22, 2021.
- <sup>xvi</sup> Texas Power Failures: What Happened in February 2021 and What Can Be Done? (page 4)
- <sup>xvii</sup> Energy Information Administration. “Texas natural gas production fell by almost half during recent cold snap,” Today in Energy, February 25, 2021
- <sup>xviii</sup> ENVERUS, “Winter Storm Uri – Natural Gas Analysis”
- <sup>xix</sup> T&DWorld, When Minutes Are Critical: ERCOT’s System Brought to the Brink
- <sup>xx</sup> ERCOT News Release May 06, 2021: Record electric demand expected this summer
- <sup>xxi</sup> NREL Interconnection Seams Study indicates that B2B (back to back) interconnections is only 1,300 MW total between the EI and WI at seven HVDC Stations.



## Energy Production, Processing and Transportation Process

### Executive Summary

During Winter Storms Uri and Viola in February 2021, the field production and processing of natural gas in Texas were significantly interrupted initially by sustained below freezing weather, which subsequently impacted electricity generation and distribution for the Texas Electrical Grid. Texas Permian Basin natural gas production experienced curtailment approaching 70% during the two storms.

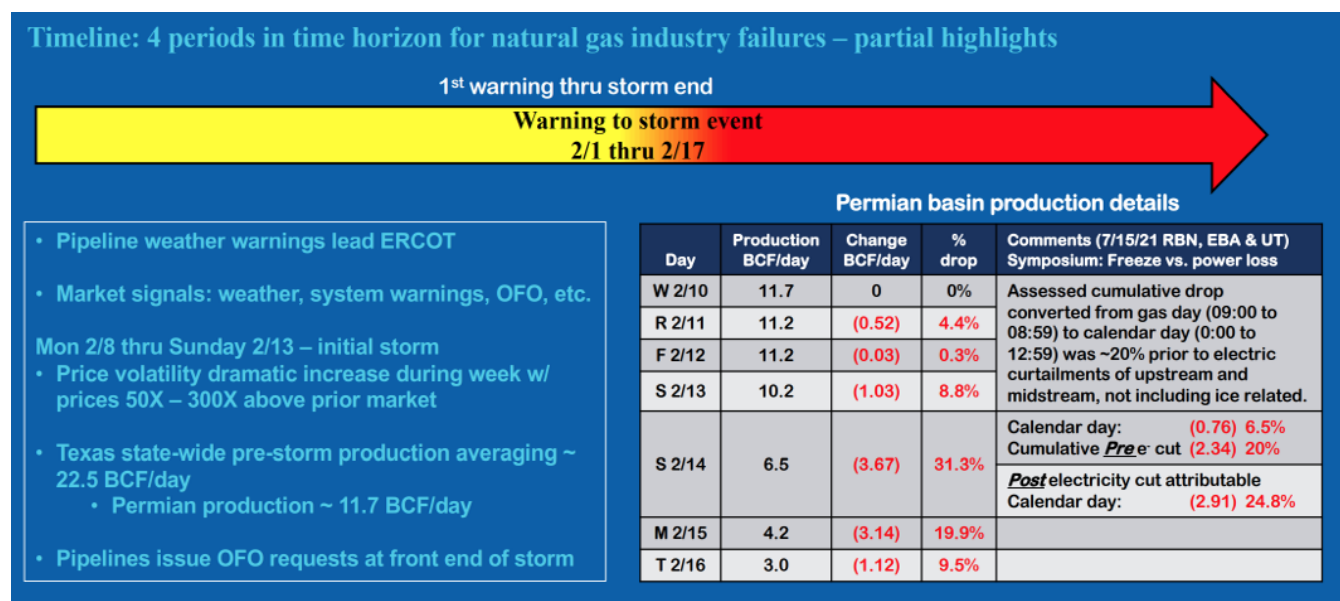

Event Data Chart no. 1 - RBN Energy LLC (data source)

Conflicting statements about causal factors for the interrupted production were issued from the Texas Railroad Commission and producers and processors of natural gas, along with the Public Utilities Commission of Texas and the Electric Reliability Council of Texas (ERCOT) accompanying the electrical power generation industry. Questions centered around the timing of the initial and continuing interruption of the flow of natural gas during the Winter Storms, and whether the causal factors thus far identified initially inhibited the ability of natural gas-powered generation facilities to operate, or whether the shutdown of natural gas-powered generation facilities consequently curtailed the ability of natural gas field production and processing facilities to operate effectively.

Characterizing the catalysts leading to the interruption of electrical energy generation in the Texas Electrical Grid during the February 2021 Winter Storms require an understanding of the elements of the entire natural gas production and processing supply chain, to identify components of the production process where sustained and unusually cold temperatures and/or absence of electrical power for equipment operations likely triggered restrictions of natural gas production. The key components of the natural gas production, processing, and transportation systems are explained in the accompanying paragraphs. With a specific intent of this analysis being to examine the independent and integrated



**Energy Infrastructure**

processes for natural gas production during the Winter Storms, we will postulate answers to the questions, “Did natural gas production systems “freeze-off” and restrict the supply of product to natural gas fired power plants, thereby initiating the ERCOT declared Energy Emergency Alert (EEA)? Or were power plant shutdowns associated with freezing of electrical generation related equipment, and subsequent Texas grid power distribution curtailment dictated by the EEA responsible for subsequent restriction of electrical power supply to natural gas production and processing operations, consequently causing electrically actuated and powered natural gas production, processing, and transportation systems to ‘shut-in’, further disrupting the power generation network?” There were consequences attributed to failures of the gas system that should be attributed to the commercial contracting practices of a majority of ERCOT based natural gas fueled electric generators that experienced fuel supply issues. These generators were negatively impacted by extensive fuel supply curtailments, but they relied upon a mixture of less costly non-firm gas supply and non-firm or interruptible transportation. This commercial issue and the related problem of revenue insufficiency is covered by the Network level report and is not repeated in this analysis.

**Natural Gas Field Production Facilities**

The typical Texas field natural gas production site is composed of production wellheads (the source of oil, natural gas, produced water), production and test manifolds (pipes connecting wells to oil and gas extraction vessels), production separators, storage tanks for oil and produced water, and compressors

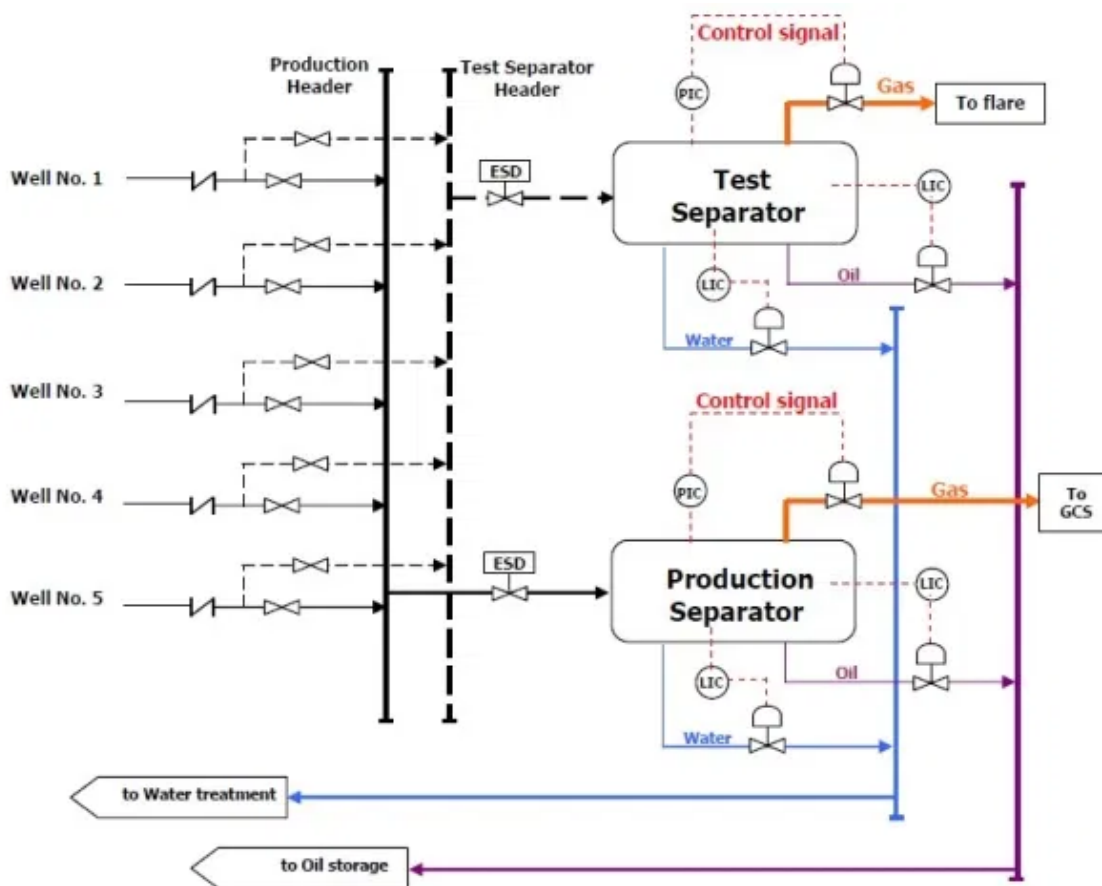

**Schematic Process Chart no. 1 – Oil and Natural Gas Field Production Layout**



to boost pressure of natural gas for transportation via gathering systems and transport pipelines to natural gas processing facilities. Separation of produced substances (oil, gas, produced water, etc.) generally occurs in multiple stages. In the production separator, oil, natural gas, and produced water are separated and further treated to meet the market or disposal well (produced water) requirements. For this system to function consistently and safely under a variety of environmental conditions, utilities including electrical power, air, water, heating, and ventilation (when process equipment is enclosed in weatherproof buildings), and Emergency Systems Shutdown / fire suppression devices are required. The sketch below shows this arrangement.

This configuration represents an industry standard that has been utilized in the oil and gas industry for decades. With design innovations introduced over time, there have been improvements in the technology applied for the oil and gas production measurement and control instrumentation, oil and produced water pumping, and gas compression for transport to downstream facilities.

Electrical power required for the production facility is sourced from the Texas Electrical distribution grid and supplied by localized power entities (Co-operative Power Suppliers, Municipal Utilities, Private Power Distribution networks). In remote locations that are isolated from the standard electrical power distribution grid, on-site internal combustion engine powered generators support the production operations, tapping into natural gas produced from the on-site wells for fuel. In unique situations, wind and solar power may be utilized as electrical power sources to sustain production at the well site.

This field oil and natural gas production well site (see figure below) reflects pictorially the well control systems (valves, level monitors, emergency shutdown controls) that require electrical power for effective control of the production facility under varying environmental and production conditions.



**Process Photo no. 1 – Field oil and gas separation vessels layout and controls**



The well production control systems perform in accordance with standard operating procedures if ambient temperatures remain within a certain range, as the equipment and instrumentation installed in Texas oil and gas field production facilities are generally not winterized (i.e., insulated, heat tape traced, or sheltered in temperature-controlled buildings).

**Winter Storms Uri and Viola in mid-February 2021 triggered natural gas well site production outages that could be traced to these specific operational and environmental factors:**

1. Wellhead and production equipment (pressure control valves, liquid/gas separators, level sensing controls) were “freeze-off” for many days due to extended cold temperatures (below 40° F), as these systems are not generally winterized in Texas. Liquids and hydrates contained in the production stream of oil, wet natural gas, and produced water, are the catalysts that precipitate the “freeze-off” of these components.
2. Loss of power to the producing well site from the electrical supply grid, resulting in the interruption of process control instrumentation and liquids pumping activation, and subsequent shutdown (shut-in) of the well’s oil and gas production.
3. Interruption of critical third-party supporting operations (field maintenance crew support, transportation services for oil and produced water from site to market or disposal, resupply of production enhancement chemicals, and well production operations related control communications equipment network services) tied to severe icy road conditions and significant icing over of electric and telecommunications utilities lines are major factors that curtail production from the field oil and natural gas well sites.

### **Midstream Natural Gas Processing**

As natural gas is one of the major fuels produced in the United States, widely used for industrial process steam and heat production; for residential and commercial space heating; and for electric power generation. Natural gas gathered from field production wells must be conditioned to meet contractually defined specifications prior to use as fuel gas. This conditioning consists of removing or reducing impurities or hydrocarbon components other than methane (water, carbon dioxide, hydrogen sulfide, helium, ethane, propane, etc.) to acceptable levels. Methane is the primary component of fuel gas. Natural gas processing plants are required for the removal of the non-methane-components. Methane exiting a typical gas processing plant will provide fuel gas with a gross heating value varying between 950 and 1050 Btu/scf (British thermal units per standard cubic foot).



**Process Photo no. 2 – Natural Gas Processing Facility**



**Energy Infrastructure**

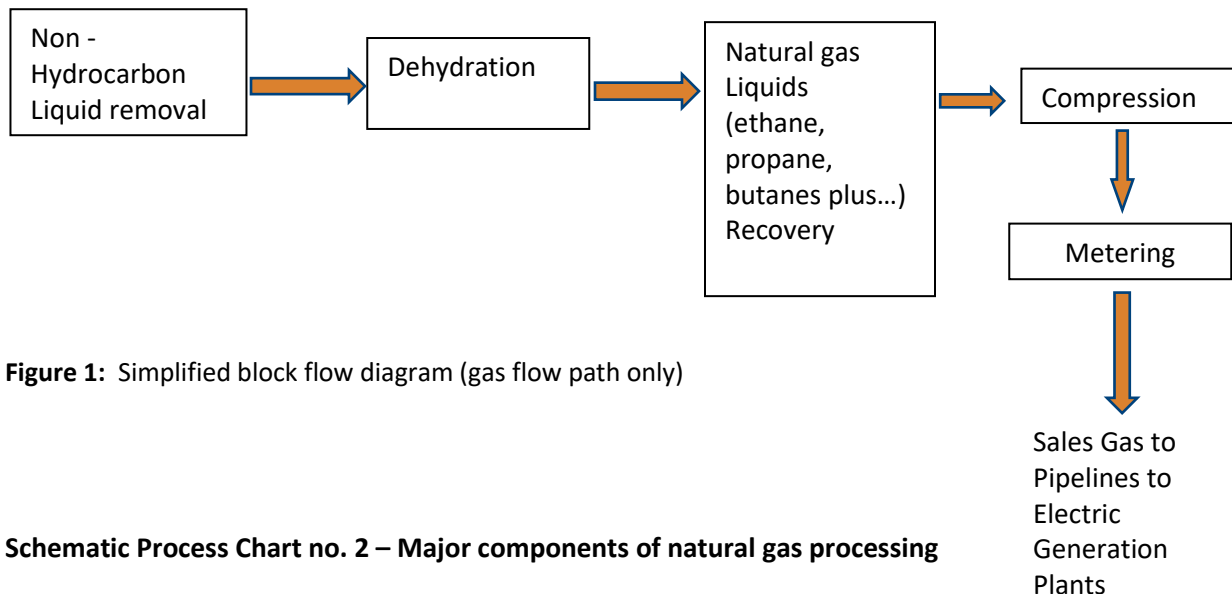

**Figure 1:** Simplified block flow diagram (gas flow path only)

**Schematic Process Chart no. 2 – Major components of natural gas processing**

The first step in natural gas processing is the removal of condensate (oil) and water, which is achieved by gravity and controlling the temperature and pressure of the inlet stream from the well. From here the gas stream (in some cases) passes to treatment for acid gas (gas containing hydrogen sulfide). Since this is not generally the case in most gas fields, it is not addressed in this simplified look at gas flow.

The dehydration of natural gas is an important step in gas processing. Natural gas is usually saturated with water vapor under production conditions. Dehydration removes residual moisture present in the produced gas stream after the initial free water knockout. This residual moisture may cause hydrate formation (an ice like formation) at low-temperature conditions which could plug control valves or piping. The most common practice to remove water from natural gas streams is to use TEG (triethylene glycol) in the gas dehydration process. TEG has a very strong affinity for water and when the TEG is in contact with a stream of water-wet natural gas, the TEG absorbs the water from the gas stream.

Next natural gas liquids, NGLs (ethane, propane, butanes plus) are extracted from the dehydrated gas stream. These liquids are generally sold to a nearby source. Gas processing plants for the recovery of NGLs are generally one of two types, Refrigeration plants or Lean oil absorption plants.

Following the NGL extraction, the treated natural gas stream that is, now mostly methane, or a gas meeting the sales gas specifications is sent through compression and meters to the pipelines for transmission or to the point of use.

**During Winter Storms Uri and Viola in February 2021, natural gas midstream production outages could be traced to these factors:**

**1. Interruption of operation of Instrumentation and Controls**

Many of the automated instruments in the natural gas mid-stream processing industry are often operated using instrument air or pneumatic signals. Instrument air is produced when atmospheric air is filtered, compressed, dried, and cooled to be used for instrument signals. Instrument air is obviously vulnerable to changes in atmospheric temperature and frozen moisture content. Consequently, because of advances in computer chip capabilities, many plants



use electrically powered instrumentation. Electrical controls installed outside the protection of a building are subject to extreme cold and moisture infiltration. Operating these controls during sustained low temperatures requires advanced preparation for those conditions. In fact, not preparing for sustained cold temperatures can sometimes result in the entire pipe system or plant shutting in, or damage to critical operating equipment. Whether electric or pneumatic, pressure transmitters would be vulnerable to sustained freezing conditions. Most pressure transmitters are built to withstand rigorous and extended use within reasonable climate temperature ranges. However, when the temperature drops to extremely low, pressure transmitters can malfunction and produce inaccurate readings. Extremely cold weather can cause water accumulation on the internal walls of piping. This same accumulation could build up within a pressure transmitter or a flow meter causing inaccurate readings or a component failure. Even if transmitters function correctly, ice and snow can freeze on external control valves and prevent them from moving in reaction to a transmitter. Preventative measures to mitigate the possibility of frozen instrumentation and control dictate the implementation of heat tracing for freeze protection.

## **2. Piping**

Frozen piping is another area of concern for plant operations in extremely cold weather. Small piping supports can act as a heat sink and cause the pipe to freeze even when insulated. The same applies to external pipe hangers that penetrate pipe lagging.

## **3. Mechanical**

Frozen precipitation can impede the operation of certain mechanical equipment (fans in aerial coolers or cooling towers). Ice forming on a forced-draft cooling tower can damage the tower internal baffles. Ice forming within the basin can reduce flow and damage the cooling tower water pumps.

## **4. Gas Conditioning Process**

Decreasing temperature and increasing pressure are favorable for hydrate formation. The formation of hydrates in natural gas processing facilities and pipelines is a critical issue because hydrates can plug equipment, instruments, and restrict or interrupt flow in pipelines. The consequences range in severity from efficiency losses, such as the restriction flow in a line, or the fouling of a heat exchanger all the way to critical hazards, such as blocking safety critical (Emergency Shutdown) instrumentation or valves. As a thumb rule, methane hydrate will form in a natural gas system if free water is available at a temperature as high as 40°F and a pressure as low as 170 psig. Methanol injection is a common technique for removing or preventing hydrates formation.

## **5. Personnel and Procedural**

Operating procedures at some plants do not permit onsite stocking of certain spare parts and replacement parts, to reduce plant overhead expenses. Instead, operators rely on outside vendors to warehouse items and deliver as needed on a “Just in Time” basis. If vendors cannot get to the plant during extreme cold weather because roads are impassable, critical material deliveries would be delayed.





**Process Photo no. 3 – Natural Gas Pipeline Compressor Station**

Transportation of natural gas to market customers is performed using large diameter pipelines, with compressors providing the power to move the gas through the lines. Compressor stations are placed strategically within the gathering pipeline (diameter: about 6-20 inches) and transmission pipeline (diameter: 20-48 inches) to help maintain the pressure and flow of gas to market.<sup>1</sup> The natural gas is generally pressurized at 800-1200 psi on an intrastate transmission pipeline. The natural gas must be periodically compressed and pushed through the pipeline to have a continuously optimal flow. The compressor stations are usually placed 40-70 miles apart along the pipeline to boost the pressure as the friction and elevation differences slow the gas and reduce the pressure.

Most compressor stations are fueled by the natural gas through the station, but all or some of the units in some areas of the country may be electrically powered primarily for environmental or security reasons. For example, **EnLink**, a major natural gas pipeline transportation company in Texas has an underway plan to convert natural gas-driven compressor engines to run on electricity that will be supplied from the Texas Electrical Grid, to tap into “Green Power” generation from wind and solar assets connected to the Grid.<sup>2</sup>

**During Winter Storms Uri and Viola in February 2021, natural gas compression driven transportation outages could be traced to these factors:**

1. Long Distance Natural Gas Line Compressor power supply interruption  
Most compression for transport in intrastate and interstate natural gas pipelines is accomplished using natural gas-powered internal combustion engines. The controls for these internal combustion engine operated compressor stations are electrically powered. Compressor Stations



## Energy Infrastructure

lacking back-up electrical generation capacity to power the compression station controls would shut down if electrical power is interrupted.

For those transportation systems employing electrical motor-powered compressors rather than internal combustion engines, interruption of electrical power to the compressor motors triggered compressor station shutdown and a significant drop in pressure in the natural gas pipelines.

### 2. Compressor Station Control Systems

Controlling systems for monitoring compression and engine or motor operations would be impacted if the electrical power supply becomes intermittent or is curtailed completely. Interruption of the supply of electrical power will result in shutdown of the compressor station and a significant reduction in the pressure of the natural gas being transported through the pipeline.

## The Grapes of Wrathful Interdependence

*How the interconnection of the natural gas production supply chain and market colluded with the natural gas-powered electrical generation plants and wholesale electrical power market to undermine reliability and resilience for the Texas Electrical Grid controlled by ERCOT during Winter Storms Uri and Viola.*

### Analysis of data

Research by the Energy Sector Sub-Committee of the Texas American Society of Civil Engineers for the Beyond Storms Committee report revealed the following factors that contributed to the near collapse of the Texas Electrical Power Grid during Winter Storms Uri and Viola.

1. “Freeze-Off” of field natural gas production systems at the well head and at downstream natural gas processing facilities, beginning in earnest on February 10, 2021.
2. Presence of significant amounts of “produced water” generated from hydraulic fracturing production methods in general use, especially in the Permian Basin, which enhanced the likelihood of “Freeze-Off” occurring at the well-head.
3. Lack of winterization of well-head facilities (usually employing heat tracing tape, insulation), especially well-head pressure and flow control valves, which are prone to freezing due to the imposed pressure drop across the valves.
4. Sustained ambient temperatures below 40° F, which have the effect of causing crystallization of hydrates incumbent in natural gas production.
5. Electrically powered production control systems and pumps at the individual and consolidated well production and separation sites, which shut down production when electrical power is interrupted, as a safety precaution.
6. Participation by some major natural gas producers in an “Interruptible Electrical Power Supply” Program, employed by ERCOT when an Emergency Electrical Activity (EEA) is declared, resulting in the unintended interruption of natural gas delivery to some natural gas-powered electrical generation facilities during peak winter demand.
7. Mismatch of Natural Gas Trading Day hours with “Day Ahead” Natural Gas-Powered Electrical Generation Plants Markets for “spot market purchase” of fuel, leading to lack of availability of natural gas during peak demand period.



**Energy Infrastructure**

8. Reliance on non-firm commodity supply and non-firm or interruptible transportation contracts for natural gas supply between natural gas marketing entities and natural gas-powered electrical power generation facilities, tied to the ongoing financial uncertainty associated with “Energy Only” market management, as ordained by Public Utility Commission of Texas.
9. Failure to recognize and mitigate the effects of the significant two-way interdependence between the natural gas supply chain (production, processing, compression for transportation) and the natural gas-powered electrical generation supply chain, by the Texas Railroad Commission, ERCOT, and the Public Utilities Commission of Texas.

**Availability of Data**

The Texas ASCE Energy Sector Sub-Committee mailed detailed questionnaires to twenty-one oil and natural gas production companies in October 2021, in the aftermath of the February Winter Storms (see full body of questionnaire in Addendum to this Report).

As no questionnaires were returned within a reasonable timeframe, the Energy Sector Committee subsequently researched publicly available information gleaned from a variety of sources in the industries impacted, and from other investigations conducted by organizations familiar with the impacted industries.

**“What Really Happened...”**

**Rapid Decrease in Generation Causes Frequency Drop**

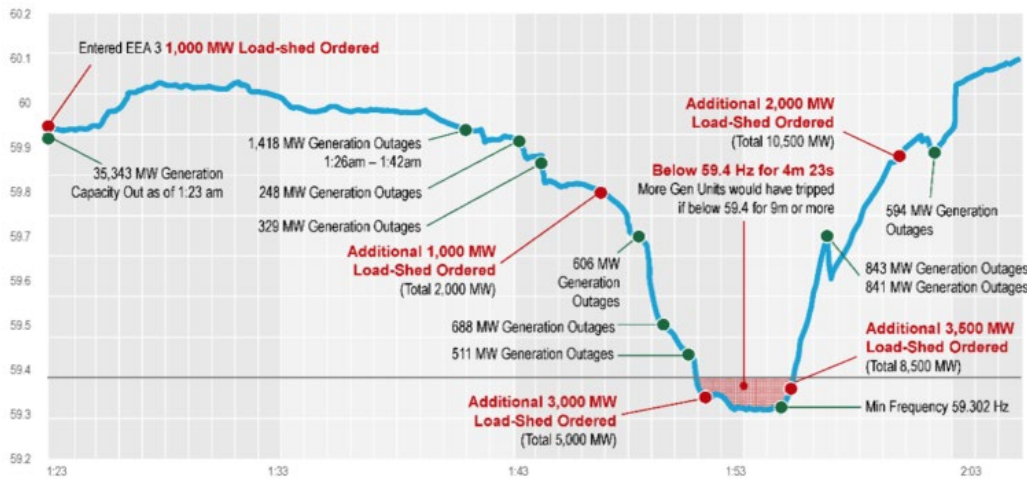

PUBLIC

12

Figure 2.j. The ERCOT grid frequency during the critical time of load shedding and generation capacity outages on the morning of February 15, 2021 (ERCOT, 2021).

**Event Data Chart no. 2 – ERCOT Timeline reflecting timing of significant power interruption**



Energy Infrastructure

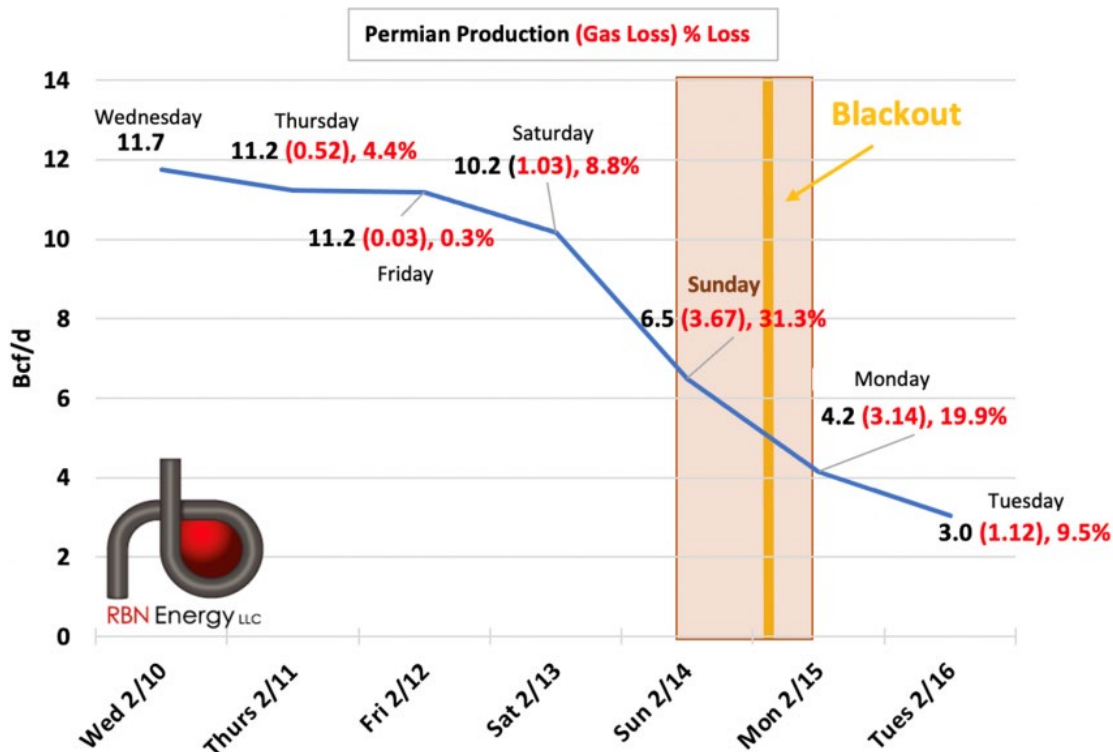

Event Data Chart no. 3 – RBN Energy Timeline for Permian Basin Gas Production Decline

Data presented by RBN Energy LLC during the Energy Symposium in July 2021, sponsored by the **Energy Bar Association** and the **University of Texas**, offers a perspective defining the drop in natural gas production that occurred before the significant curtailment of electrical power generation in the early morning hours of February 15, 2021. The fact that 20% of natural gas production went offline before the interruption of electrical generation starting on February 15 at 1:23 am and culminating with the major load shed event at 1:50 am, can only be reasonably explained as being the result of a “freeze-off” at upstream natural gas production facilities (wellheads and mid-stream processing facilities). The precipitous decline of 54.2 % of natural gas production during the remainder of the major load shed event can then be attributed to the abrupt and extended loss of electrical power to upstream natural gas production facilities, interstate and intrastate natural gas pipelines including compression stations, and downstream natural gas distribution facilities.

Further investigation by energy focused agencies and Texas newspapers revealed that some natural gas production operations had registered to be disconnected from the Texas Electrical Grid in the event of an EEA, even though they were deemed to be critical suppliers for natural gas fired electrical power generation facilities. These production operations opted for this disconnection in part because they did not know that they were critical suppliers for electrical power generation, and in part because ERCOT offered compensation for the privilege of being able to disconnect these operations in a load shedding event, to quickly stabilize the grid and prevent collapse of the power generation and distribution network. At the time of publishing of this analysis, natural gas suppliers known to be critical sources of



**Energy Infrastructure**

fuel for electrical generating facilities have applied for waivers to prevent them from being disconnected from the grid, to prevent the expansion of a load shedding event beyond that which impacts a limited region of the Texas Electrical Power Generation and Distribution Grid controlled by ERCOT.

**Net Generator Outages and Derates by Cause (MW)**  
February 14 – 19, 2021

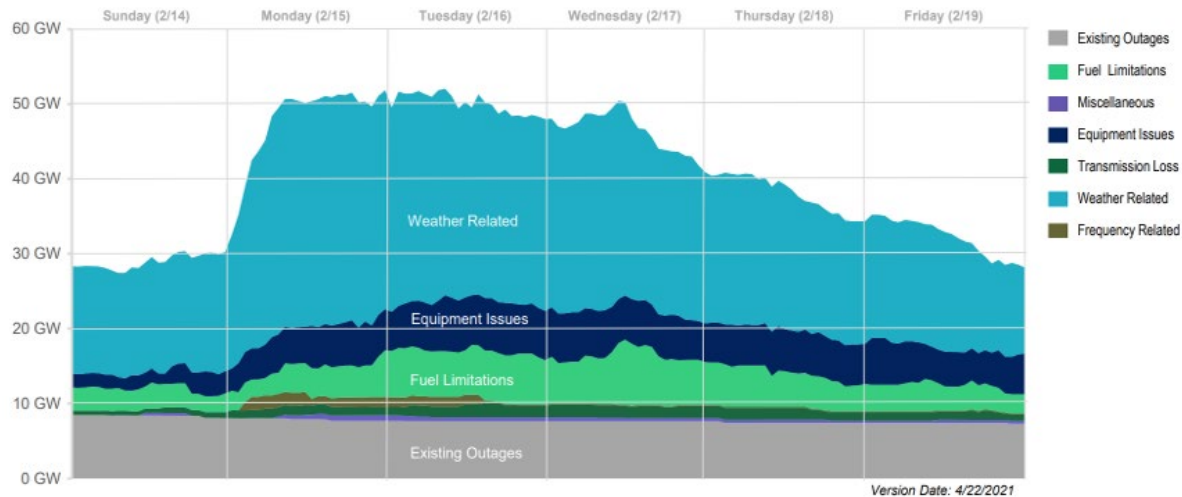

Net generator outages at the beginning of each hour on February 14-19, 2021, by cause category.



PUBLIC

4

**Event Data Chart no. 4 – ERCOT Generator outage timing by assigned cause factors**

Electrical power generation companies feeding the Texas electrical grid managed by ERCOT have consistently maintained that the decline in availability of natural gas for fuel stock precipitated the major load shed event on February 15<sup>th</sup>. As this chart from ERCOT demonstrates, fuel limitations were not a major factor in the decline of electrical power generation until after the load shedding activities commenced at 1:53 am on Monday, February 15<sup>th</sup>, and peaked on Wednesday, February 17<sup>th</sup>. It is reasonable to infer that the shut-ins of upstream natural gas production due to lack of electrical power beginning at 1:53 am February 15<sup>th</sup> merely exacerbated the crisis. Recovery of natural gas production and delivery was restored in unison with the restoration of electrical power to those production facilities, as the severe cold weather abated toward the end of the week.

An additional aspect of this event is noteworthy: According to NERC/FERC cold weather report November 2021: buried in the depths of the report figure 103 on page 204 confirm that most of the generators that experienced derates outages had a mixture of **firm** and **non-firm** commodity and transportation contracts – they bought interruptible service and were caught unprepared when they were precluded from obtaining natural gas during the EEA. Only 24% of the ERCOT units experiencing problems had both firm supply and transport. This 24% that had problems is unacceptable and this can be parsed into the interdependence impacts, but most power plants “got what they paid for” contractually. Resolution of this issue is addressed in recommendations.

While the Energy Sector Sub-Committee was unable to obtain cause-specific data from the natural gas producers, available data sampled as part of the ongoing research on the topic of “freeze-off” conditions



**Energy Infrastructure**

generated some aspects of conditions in the field during Winter Storms Uri and Viola that are worthy of reflection.

States sampled in this analysis account for 75% of total US production; states with the highest likelihood impacts of temperature decreases make up nearly 50% of total US production.

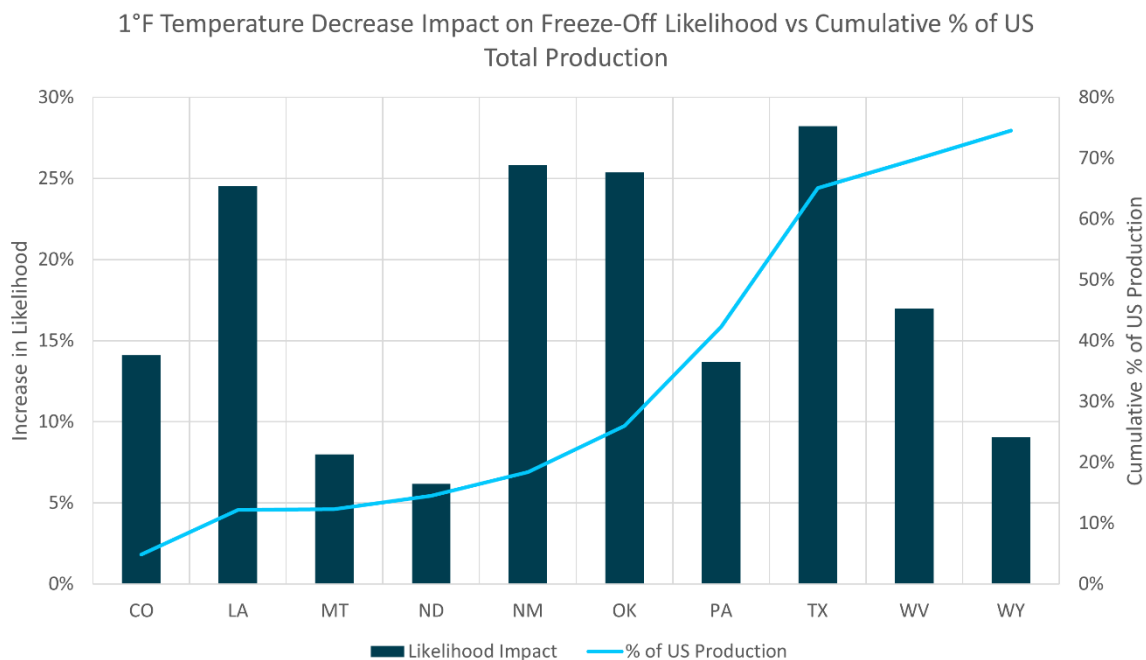

[www.btuanalytics.com](http://www.btuanalytics.com)  
[info@btuanalytics.com](mailto:info@btuanalytics.com)

1

Source: BTU Analytics, EIA

**Event Data Chart no. 5 – BTU Analytics Freeze-Off Cumulative impacts per Degree Temperature Drop**

According to **BTU Analytics**, “using a model that estimates the likelihood of a freeze-off based on a 1°F decrease in temperature below freezing, in Texas (holding all else constant) a 1°F decrease in temperature increases the odds of a freeze-off by a daunting 30%.” Clearly, Texas and especially the Permian Basin, were in the throes of conditions that generated “freeze-offs”. The effective natural gas volume reduction associated with the phenomenon of “freeze-off” in natural gas production is summarized in the chart shown above. Note that Texas stands the highest likelihood of experiencing significant interruption of natural gas production associated with “freeze-off” related conditions.

Components most likely to freeze-off first include control valves and tubing that provide compressed air for the actuation of well related controls. Various oilfield equipment suppliers offer recommendations for increasing the resilience of these components during the advent of extended periods of cold weather.

It has been previously stated that in operational environments where cold weather is a regular and sustained occurrence, the injection of chemicals like methanol assists in the reduction of the likelihood of experiencing “freeze-off” at control valves and other flow constraining devices in the natural gas production stream.



Finally, critical components in the natural gas production stream may be heat traced with electrically powered tapes (example: Thermon Manufacturing Company of San Marcos, Texas), to provide heating elements to envelop and warm those components during cold weather occurrences. Insulation of control valve bodies is also a suitable option, when deemed necessary because of the designation of a natural gas production operation as a critical component of the electrical generation and distribution grid.

## RECOMMENDATIONS:

1. Texas Oil and Natural Gas Production Companies should review and apply cold temperature process protection procedures in field production well sites of areas in the mid-continent of the United States, that maintain oil and natural gas production during sustained cold weather to both existing and planned production infrastructure.
2. Special attention should be given by field oil and natural gas production maintenance crews to heat tracing and/or insulating elements of the field oil and natural gas production process where valves are used to throttle the flow of process fluids and gases, as those locations are likely sources of initial “freeze-off” in the field.
3. Oil and Natural Gas Production companies that supply fuel to natural gas fired power generation facilities in the Texas Grid should apply for exemption from having electrical power interrupted during an ERCOT declared EEA and be unable to participate in incentives for electric load curtailment.
4. Oil and Natural Gas Production Companies should work in concert with the Public Utilities Commission of Texas, the Texas Railroad Commission, and natural gas fired power generation companies to develop approaches to ensure that electric generators are acquiring the quality of firm and non-firm supply and transportation services and related services such as market area storage needed for reliable power generation to meet peak winter demand periods. This effort must respect the quality of contracted service and not expect subsidization of electric generators by the natural gas industry to provide services more than the level contracted and paid for, eroding reliability of the natural gas industry, and shifting costs to other users of the natural gas system.
5. Oil and Natural Gas Production Companies should work in concert with the Public Utilities Commission of Texas, the Texas Railroad Commission, and Liquefied Natural Gas processing and exporting companies to develop contractual requirements for temporarily curtailing the supply of natural gas to these export entities during the time that an ERCOT declared EEA is in force in return for appropriate compensation.
6. Oil and Natural Gas Production Companies should equip field production maintenance crews with adequate equipment (tire chains, cold weather clothing and special footwear for traversing ice covered equipment, satellite capable mobile phones, extra vehicle fuel capacity, portable power generation equipment) like articles and equipment that emergency responders would have in inventory. The intent would be to introduce the capability to respond safely on an emergency basis to remote well sites in the event of a severe weather service interruption.



## Summary

The Energy Sector Sub-Committee determined that “freeze-off” of natural gas production was a factor in precipitating some aspects of the February major load shedding event. However, other factors highlighted by the Network Sector Sub-Committee, including the impact of the extended cold weather generated by Winter Storms Uri and Viola and incipient contractual obligations and market dynamics, played outsized roles in the cascading disruption of the electrical generating capacity for the Texas Electrical Grid.

Had adequate methods of heat tracing and insulating of critical field natural gas production components been employed, the flow of natural gas to gas fired generating facilities would have been sustained at a higher level, perhaps at most 20% or 2.34 BCF, in advance of the severe interruption of electrical power in the early hours of February 15<sup>th</sup>. That availability of additional natural gas may have served to mitigate the severity of the load shed event, to a degree that at this time can only be estimated by ERCOT and the electrical power generation companies feeding the Texas Grid.

The Recommendations of the Energy Sector Sub-Committee, intended to mitigate the recurrence of significant interruptions of natural gas fuel supplies to critical power generation operations in the Texas Electrical Grid are restated as follows:

1. Review and apply cold temperature process protection procedures used in field production well sites of areas in the mid-continent of the United States.
2. Install heat tracing and/or insulating elements to the areas of field oil and natural gas production process where valves are used to throttle the flow of process fluids and gases.
3. Natural gas production operations supplying the Texas Electrical Grid should apply for exemption from having electrical power interrupted during an ERCOT declared EEA and be unable to participate in incentives for electric load curtailment.
4. Regulating entities managing the Texas electrical grid and the Texas oil and natural gas industry should implement approaches to ensure that electric generators are acquiring the quality of firm and non-firm supply and transportation services and related services such as market area storage needed for reliable power generation to meet peak winter demand periods. This effort must respect the quality of contracted service and not expect subsidization of electric generators by the natural gas industry to provide services more than the level contracted and paid for, eroding reliability of the natural gas industry and shifting costs to other users of the natural gas system.
5. Regulating entities managing the Texas electrical grid and the Texas oil and natural gas industry should develop contractual requirements for temporarily curtailing the supply of natural gas to Liquefied Natural Gas export facilities during the time that an ERCOT declared EEA is in force in return for appropriate compensation.
6. Texas oil and natural gas field production operations should supply field maintenance crews with articles and equipment that provide the capability to respond safely on an emergency basis to remote well sites in the event of a severe weather service interruption.





## Sources

- *'Can We Just Talk? - Symposium Explores How Natural Gas Fits into ERCOT Reliability'* – RBN Energy LLC, July 26, 2021
- *'2021 EBA Texas Symposium: The Texas Energy System at the Crossroads: Lessons in the Wake of Major Storms'* - Energy Bar Association and co-sponsored by the University of Texas Law School, July 15, 2021 (attended in person by Oliver Smith, Texas Section, ASCE)
- *'FERC - NERC - Regional Entity Staff Report: The February 2021 Cold Weather Outages in Texas and the South-Central United States'* – November 2021
- *'Future Compressor Station Technologies and Applications'* - Southwest Research Institute February 9, 2012, Gas Electric Partnership Conference
- *'5 Safety Tips for Oil and Gas Production Cold Weather'* – Kimray Valve Company YouTube Production
- *'Investigating Freeze-offs: The Cold Hard Truth'* - BTU Analytics, October 23, 2018



## ADDENDUM

### ASCE Texas Section Beyond Storms: Natural Gas Field Production Assessment Questions

**Directions:** Please answer the questions listed to the best of your knowledge.

#### Natural Gas Field Production Interruption Assessment

1. Were any of your company’s field natural gas well production systems shut in at all between February 10 and February 19, 2021 (Winter Storm Uri)?

YES		SOMEWHAT		NO
-----	--	----------	--	----

2. If some field natural gas well production systems did shut down during Winter Storm Uri, were critical components of the field production system powered by electricity from suppliers tied to the Texas Electrical Grid?

YES		SOMEWHAT		NO
-----	--	----------	--	----

3. Do the field natural gas well systems powered by electricity from suppliers tied to the Texas Power Grid also have independent backup power generation capability?

YES		SOMEWHAT		NO
-----	--	----------	--	----

4. Did the field natural gas well systems begin to “freeze off” and limit production of natural gas and other products at temperatures below 40 degrees Fahrenheit?

YES		SOMEWHAT		NO
-----	--	----------	--	----

5. During the period from February 10 through February 19, were your field production support and maintenance crews able to service the field production locations (not limited in traveling to sites by icy roads and travel conditions)?

YES		SOMEWHAT		NO
-----	--	----------	--	----

6. During the period from February 10 through February 19, were your field natural gas production operations hindered or interrupted by the inability to dispose of “produced water” generated during production?

YES		SOMEWHAT		NO
-----	--	----------	--	----

7. During the period from February 10 through February 19, circle all components of the field natural gas production operations that were restricted by “freeze off” or absence of power to controls:

- a. Valves (all types)
- b. Instruments (level control)
- c. Separators
- d. Manifolds
- e. Production Pipes (liquid and gas)

8. During the period from February 10 through February 19, were your field natural gas production well monitoring systems affected in such a way as to require production shut in?

YES		SOMEWHAT		NO
-----	--	----------	--	----

9. During the period from February 10 through February 19, were your field gathering pipeline systems affected in such a way as to require production shut in?

YES		SOMEWHAT		NO
-----	--	----------	--	----

10. During the period from February 10 through February 19, were your downstream natural gas processing systems (e.g., fractionation plants, dehydration facilities, gas conditioning, compression, etc.) affected in such a way as to require production shut in?

YES		SOMEWHAT		NO
-----	--	----------	--	----



## Background

Transportation is essential to any economy, and especially for a state as large and as fast-growing as Texas. The population in Texas may *double* by 2050 to more than 54 million. The anticipated growth implies the need for significant expansion and improvement of the state's transportation infrastructure.

Future capacity to serve user demand is not only the sole consideration in planning for the future. As experienced during Winter Storm Uri, there is a need to consider emergency preparedness to allow for a minimal level of functionality in extreme weather conditions.

### How it works: **Modes of the Transportation Sector**

In its most fundamental form, the transportation sector includes infrastructure in the following transportation modes:

- Highway and Motor Carrier (highways, roads, bridges, tunnels, and vehicles).
- Aviation (aircrafts, air traffic control systems, airports, heliports, and landing strips).
- Mass Transit and Passenger Rail Lines (terminals, operational systems, and supporting infrastructure for passenger services by transit buses, trolleybuses, monorail, heavy rail such as subways or metros, light rail, passenger rail, and vanpool/rideshare).
- Freight Rail (major carriers, smaller railroads).
- Maritime Transportation (coastline, ports, and waterways).
- Pipeline Systems (pipelines spanning the state and carrying petroleum, natural gas, and other hazardous and non-hazardous liquids, and above-ground assets, such as compressor stations and pumping stations).

### Importance of this sector: **Transportation Sector Infrastructure in Texas**

The various modes of the Transportation Sector include infrastructure used by individuals to transport people and goods over a distance.

- Roads and Highways (moving people and goods): Texas has nearly 314,000 miles of roads and highways, more than any other state. About a quarter of the total represents the state highway system, with the remainder maintained by local governments.
- Aviation (moving people): Texas has nearly 400 public airports, including 24 commercial service airports, which offer regularly scheduled flights and serve millions of passengers annually. Among these are two of the nation's largest and busiest, Dallas-Fort Worth International Airport and George Bush Intercontinental Airport in Houston. The remainder are general aviation airports, serving a variety of private aircraft and small charter operations.
- Mass Transit Systems and Passenger Rail (moving people): The federally funded Amtrak system provides limited passenger service in Texas. Other public passenger transport is provided by dozens of urban and rural transit systems and eight metropolitan transit authorities, which derive operational funding from fees and local sources and capital funding (for vehicles, construction, etc.) primarily from bond issues and other financing as well as federal grants.



## Transportation Infrastructure

- **Freight Rail (moving goods):** Texas also has the largest share of rail lines among states, with more than 10,400 miles of track. According to TxDOT, 49 railroad operators move freight in Texas, including three of the nation’s largest (“Class 1”) rail companies.
- **Marine Ports and the Intracoastal Waterway:** Texas has 21 seaports that handle many million tons of cargo. Houston, Beaumont, and Corpus Christi ports of Texas are among the nation’s ten busiest in terms of tonnage handled.

### Jurisdiction: **Agencies/jurisdictional authorities for the transportation sector in Texas**

There are many miles to travel in Texas, many places to go and many ways to get there. The Texas Department of Transportation (TxDOT) is one of the governmental agencies that helps people reach their destination safely and efficiently when it comes to road travel. The U.S. Federal Aviation Administration (AAA) is the agency that regulates more than half of all air traffic. Connections made through the airport system provide for the continued growth of Texas’s metropolitan areas while providing invaluable access to the state’s more rural communities. Maritime transportation and port facilities are important parts of the Texas transportation system. The Railroad Commission of Texas no longer has any jurisdiction or authority over railroads in Texas, a duty which was transferred to other agencies, with the last of the rail functions transferred to the Texas Department of Transportation in 2005. The Port Authority Advisory Committee (PAAC) is a nine-member committee created by state legislature that advises the Texas Transportation Commission and TxDOT on matters relating to port authorities and provides a forum for the exchange of information between the Texas Transportation Commission, TxDOT, and representatives of the Texas maritime and port industry.

### What it includes: **Transportation Sector At-A-Glance**

Texas’ central location and state-of-the-art transportation network is setup to provide timely access to domestic and global markets via air, land, and sea.

TRANSPORTATION NETWORK	
HIGHWAYS, ROADS & BRIDGES	
Total Road Mileage	313,220
Rural Mileage	212,910
Urban Mileage	100,310
Number of Bridges	53,018
AIRPORTS	
International	25
Public	387
Private	1084
TRANSIT & RAIL	
Bus Route Miles	13,724
Transit Route Miles	349
Number of Transit Agencies	51
FREIGHT RAILROAD	
Railroad Miles	10,539
Number of Railroads	49
PORTS & WATERWAYS	
Miles of Inland Waterways	830
Total Shipments (1,000 tons)	485,884



Domestic Shipments	64,451
Foreign Shipments	346,390
Intrastate Shipments	75,043
Number of Waterway Facilities	1,639

Data based on American Road & Transportation Builders Association and Texas Economic Development Corporation figures

The anticipated population growth for Texas means significant expansion and improvement of the state’s transportation infrastructure: its roads, rail lines, airports, marine ports, and waterways.

As part of the Infrastructure Investment and Jobs Act bill signed into law in November 2021, the White House estimates that Texas will receive about \$35.44 billion over five years for roads, bridges, pipes, ports, broadband access, and other projects.

The breakdown of the funds that Texas anticipates is the following:

- Federal highway programs: \$26.9 billion
- Public transportation: \$3.3 billion
- Drinking water infrastructure (and removing lead pipes): \$2.9 billion
- Airports: \$1.2 billion
- Bridge replacement and repairs: \$537 million
- Electric vehicle charging network: \$408 million
- Broadband expansion: \$100 million
- Wildfire protection: \$53 million
- Cyberattacks protection: \$42 million

#### Problems that occurred: **2021 Winter Storm Uri Impact on the Transportation Sector**

The North American Winter Storm (Winter Storm Uri) period extended from February 13-17, 2021, which caused widespread impact across the country and Texas.

- Supply chain disruption
- Vehicle Accidents
- Loss of Life

Winter Storm Uri stranded many transport trucks en route, delayed transit times, and shut down shippers and receivers. Sea ports became increasingly backlogged and many rail roads, including Union Pacific, shut down for periods of time. As a result, truck capacity plummeted which resulted in steep spikes for demand in the market and put pressure on contracted pricing.

Disrupted power supplies caused freight that normally would take one day to cross into Laredo to take two (2) to three (3) days. The longer the border crossing was closed, the more freight piled up adding to the bottleneck effect. Mexican imports by truck were delayed for days which impacted the state and the nation.

Treacherous road conditions kept many drivers out of Texas, and those drivers still in the state stayed parked. Carriers who remained on the road had to be especially careful when planning their routes, as fuel stations across the state were closed due to frozen lines. To aid with fuel supply, the Texas Comptroller’s Office lifted the restrictions on selling off-road diesel from February 12<sup>th</sup>– 26<sup>th</sup> to ensure

## Transportation Infrastructure

emergency response vehicles, power company service trucks and transport trucks carrying supplies for disaster relief could stay on the road.

Ongoing issues with driver shortage and the rise in the demand for e-commerce freight due to the COVID-19 pandemic limited truck capacity in the market. When Texas roads began to close due to unsafe conditions, trucks shut down within the state and others never ventured into it. Additionally, this happened around the President's Day weekend which typically experiences a drop-off in truck capacity. The tight capacity and almost desperate demand to move freight continued to push rates higher.

Truckload capacity is not the only mode of transportation that was impacted. Small parcel and final mile shippers were backlogged as several carriers had shut down offices in Texas.

Even as the Texas climate returned to normal, freight demand did not get a break. Customers who were unable to procure essential items during the blackouts depleted store inventories as they restocked their homes creating another spike in truck demand. The heavy backlog of freight would have been easier to recover if the effects of Winter Storm Uri were confined to a single state; instead, the weather system caused disruptions in several markets making reconnecting supply chains more difficult.

The treacherous driving conditions resulted in hundreds of car accidents. The most notable of these accidents was the 130-vehicle pile-up on Interstate Highway 35 near downtown Fort Worth, TX that claimed six lives.



According to TxDOT, when gas heat and electricity became unavailable to Texas homes and workplaces, transit staff brought buses to Texans in need, providing safe, heated spaces where they could warm up and charge their phones and computers – even when the drivers were contending with the loss of heat, power and/or water at their own homes.



### Preparedness: **Governmental Agencies Emergency Operations for Snow and Ice**

TxDOT uses multiple methods to prepare for and address winter weather, striving to minimize snow and ice accumulation on highways. Preparedness for ice and snow response begins as early as possible before the first freeze of the season. TxDOT employees proactively respond to icy and snowy conditions once the weather arrives.

Application of Materials – TxDOT applies anti-icing materials to prevent ice formation or de-icing material to remove ice and may apply traction materials such as the following to help prevent vehicle sliding:

- Sand
- Crushed stone
- Crushed slag

Timing is key. TxDOT crews carefully time the applications with local weather forecast to maximize the effectiveness of the applications. When possible, TxDOT employs pre-treatment strategies in advance of potential winter storms. The application of anti-icing materials in advance of freezing weather can significantly limit or prevent the bonding of ice to pavement and bridges.

Before, during, and after a storm, TxDOT personnel monitor conditions by making on-site observations, reviewing camera images, and checking news reports and feedback from the public.

Snow and Ice Removal – TxDOT deploys employees, in strategic locations, with equipment to plow snow and blade ice so that motorists can use the road. TxDOT now follows a four-tier system for treating all primary state highways across the State:

- Tier I – state roadways that affect the movement of interstate commerce and receive priority for pre-treatment and de-icing.
- Tier II – state roadways that are of high priority locally or regionally and TxDOT identifies treatment actions in collaboration with local governments.
- Tier III – state roadways that are low-volume roadways that primarily service local areas that receive treatment depending on available resources; and
- Tier IV – state roadways that are low-volume roadways that primarily service local areas that receive treatment on problem areas.

TxDOT districts have adequate material to pre-treat or de-ice every Tier I roadway under its responsibility. TxDOT uses its mobile fueling tanks as needed to keep up with the fleet fuel needs and, if necessary, to refuel stranded motorists.

During snow and ice operations, communications about road conditions include safety messages to the traveling public to stay off slick, icy roads or to be vigilant of the possibility of snow or ice on bridges and roadways.

### Proposed recommendations: **Foster a more robust and resilient transportation sector**

The state's transportation needs are booming along with its cities, and its economy depends heavily on the free flow of goods by truck, train, airplane, and ship. An efficient transportation infrastructure is essential to fostering economic growth and ensuring our citizens' lives are healthy and prosperous.



## Transportation Infrastructure

- **Greater preparedness for weather extremes:** The impacts from winter storms Uri and Viola were severe and often exceeded scenario assumptions included in emergency operations plans. This requires greater preparedness for harsh weather conditions in the future. A comprehensive review of issues and a consideration of lessons learned from other infrastructure sectors, such as ensuring manual access to electronically secured facilities during power outages and ensuring steps have been taken to mitigate interdependence risks from loss of power supply at critical facilities are some of the areas for consideration. This review should include the identification of risk areas for improved maintenance and modernization efforts.
- **Consider updates to Emergency Operations plans:** TxDOT has a well-developed Standard Operations Plan (SOP) for emergency Operations in Snow and Ice. This system includes a four-tiered system of road prioritization for treating primary state highways across the State. Tier II focuses on local and regional roadways of importance in collaboration with local governments. This should be expanded with input from the electric and natural gas industries, the TRC and the PUCT to ensure that access to critical energy infrastructure is included in the prioritization.
- **Education and Outreach:** Extreme weather conditions highlighted the need for education of the public about extreme weather warnings, including governmental agency warnings to the public to stay off road during inclement weather to prevent or minimize a need for first emergency responders. Assist local government agencies to adopt TxDOT's approach to conduct emergency exercises to assess emergency response plans and ensure reliable local and regional communication during emergency events. The exercises help identify ways to improve the plan's features for safe and reliable performance during a winter weather response.





## Transportation Infrastructure

### Sources

- <https://www.transportdive.com/news/Texas-winter-storm-Polar-Vortex-trucking-freight-rates/597652/>
- <https://traffix.com/blog/winter-storms-in-texas-disrupt-supply-chains>
- <https://www.txdot.gov/inside-txdot/division/public-transportation/transit-providers-response.html>
- <https://www.txdot.gov/driver/weather/winter-travel.html>
- <https://www.forbes.com/sites/willyshih/2021/02/19/severe-winter-weather-in-texas-will-impact-many-supply-chains-beyond-chips/?sh=4b4d94f6358a>
- [https://www.joc.com/trucking-logistics/winter-storms-deal-another-blow-us-supply-chains\\_20210217.html?page=1](https://www.joc.com/trucking-logistics/winter-storms-deal-another-blow-us-supply-chains_20210217.html?page=1)
- <https://www.freightbrokerscourse.com/blog/2021/02/17/2-effects-logistics-texas-winter-storm/>
- <https://www.weather.gov/hgx/2021ValentineStorm>
- <https://www.klfy.com/local/us-190-sees-an-influx-of-traffic-due-to-i-10-closures-because-of-conditions-brought-on-by-winter-storm-2021/>
- <https://www.click2houston.com/news/local/2021/02/13/how-counties-in-houston-area-are-preparing-roads-ahead-of-winter-storm/>
- <https://comptroller.texas.gov/economy/fiscal-notes/2018/may/transportation.php>
- <https://comptroller.texas.gov/economy/fiscal-notes/2021/oct/winter-storm-impact.php>
- [https://ftp.dot.state.tx.us/pub/txdot-info/sla/education\\_series/emergency-ops.pdf](https://ftp.dot.state.tx.us/pub/txdot-info/sla/education_series/emergency-ops.pdf)
- <https://ftp.txdot.gov/pub/txdot-info/avn/tx-econ-tech.pdf>
- <https://tti.tamu.edu/researcher/the-last-stop-with-greg-winfree-16/>
- <https://www.texastribune.org/2021/11/09/biden-infrastructure-bill-texas/>
- [https://www.artba.org/wp-content/uploads/2016/08/econ\\_profile\\_2015\\_Texas.pdf](https://www.artba.org/wp-content/uploads/2016/08/econ_profile_2015_Texas.pdf)
- <https://artbabridgereport.org/state/profile/TX>

# Acknowledgments

ASCE Texas Section would like to recognize the following individuals for their contributions to this report:

**Patricia Frayre PE**

**2022 Vice President for Professional Affairs**

Mrs. Frayre serves as the ASCE Texas Section 2022 Vice President for Professional Affairs and, as such, oversees the Beyond Storms INR Task Committee. She is Principal at Frayre Engineering & Consulting, PLLC with a diverse engineering background and experience in drainage, water resource management, site development, construction management, and parks & greenspaces.

**Sean P. Merrell PE, PTOE, RAS, F.ASCE**

**2022 Past President**

Mr. Merrell served as the ASCE Texas Section 2021 President and oversaw all activities of the Section. He also serves as a Region 6 Governor for ASCE. He has more than 20 years of experience in the transportation engineering field. Mr. Merrell is an Associate and Senior Project Manager at BGE, Inc., where he leads the traffic group for three North Texas offices.

**Patrick M. Beecher PE**

**2022 President**

Mr. Beecher serves as the ASCE Texas Section 2022 President and oversees all activities of the Section. Patrick Beecher PE is a Senior Principal with Terracon Consultants, Inc. He serves as the Geotechnical Department Manager for Terracon's Houston office. Patrick is a licensed Professional Engineer in Texas with over 19 years of experience providing geotechnical engineering consulting for a variety of projects in Texas. Patrick received his Bachelor of Science and Master of Engineering from Texas A&M University in 1997 and 1999, respectively. He is married and has two girls. He has been a member of ASCE since 1994 and currently serves as a Section Director for the Houston Branch.



# Thank You

## ASCE Texas Sections Beyond Storms Infrastructure Network Resilience Task Committee

As a public service, the American Society of Civil Engineers regularly prepares assessment reports of critical infrastructure serving essential needs on both a state and national level. Most recently, early February 2021, the ASCE Texas Section released the most current Texas Infrastructure Report Card (IRC). As well, when a catastrophic event takes place and infrastructure fails, ASCE deploys skilled engineers from its membership to assess and determine what happened, why it happened, and more importantly, to develop recommendations for future change, as appropriate, to avert such an event. As such, ASCE Texas Section convened a task committee just as Texans experienced Winter Storms Uri and Viola. Learn more at [www.TexASCE.org/beyond-storms](http://www.TexASCE.org/beyond-storms).

The following individuals—along with several members who wish to remain anonymous—are responsible for the successful completion of the 2022 *Reliability and Resilience in the Balance* Report:

### Geoffrey D. Roberts Jr. | Committee Chair

Mr. Roberts serves as Chair of the ASCE Texas Section Beyond Storms Infrastructure Network Resilience Task Committee and oversees 6 subcommittees. Geoff has been a long-time member of ASCE, having most recently served as a sub-committee co-chair of the energy sector for the 2021 *Texas Infrastructure Report Card*. Mr. Roberts has 38 years of global experience in the energy, water, and wastewater fields. His career includes technical and commercial experience with several Fortune 500 energy corporations and Private Equity owners, including international leadership assignments developing and operating energy infrastructure and building and managing energy origination and trading businesses in North America, Europe, South America, and Asia.

#### Network Infrastructure Subcommittee

Geoffrey D. Roberts Jr.  
Mark K. Boyd PhD, PE, CAPM, DWRE  
Les W. Pittman PE, ENV SP, LEAD AP, RPLS  
Oliver E. Smith, Jr.

#### Drinking Water & Wastewater Subcommittee

Julia J. Hunt PE | Subcommittee Chair  
Denis W. Qualls PE, DWRE  
Shay Ralls Roalson, PE  
Manika Sharma  
Reem J. Zoun PE, CFM, ENV. SP

#### Electricity & Power Subcommittee

Kenneth A. Donohoo PE

#### Energy Subcommittee

Oliver E. Smith, Jr. | Subcommittee Chair  
Kenneth A. Donohoo PE  
Winfred R. Fleming  
Vikrant Joshi  
Shanru Tian

#### Telecommunications & Fiber Subcommittee

Patricia Frayre PE | Subcommittee Chair  
Griselda Gonzales PE, ENV SP  
Wesley J. Oliphant PE

#### Transportation Subcommittee

Patricia Frayre PE | Subcommittee Chair  
Sean P. Merrell PE, PTOE, RAS  
Tim Smelcer PE

## George A. Dickinson III | Manager, Business Development | Caliche Development Partners

### ASCE TEXAS SECTION STAFF

Jenni Peters, CAE – Communications Specialist 2021, Executive Director 2022

Lindsay A. O’Leary PE, CAE, LEED AP – Executive Director 2021

Mike Sosa - Operations Specialist

ASCE Texas Section is one of the largest and most active sections of the American Society of Civil Engineers. Established in 1913, the Texas Section represents nearly 10,000 members across Texas. Headquartered in Austin, the Texas Section unites 15 Branches, 7 Technical Institute Chapters, and 20 Student Chapters—including one at each major Texas university. ASCE Texas Section belongs to ASCE's Region 6, which includes the Mexico, New Mexico, and Oklahoma Sections. ASCE has 150,000+ global members. We support & encourage the equitable opportunity for participation by all.

***Texas civil engineers are leaders in their communities, building a better quality of life across the street and around the world.***

## ASCE Texas Section

[office@TexASCE.org](mailto:office@TexASCE.org)

(512) 475-8905

[www.TexASCE.org](http://www.TexASCE.org)



[ASCE\\_TexasSection](#)



[Texas Section ASCE](#)



[@TexASCETweets](#)



[Texas Section ASCE](#)